

*Thank you for choosing*

**Panasonic**  
**Omnivision** **VHS**

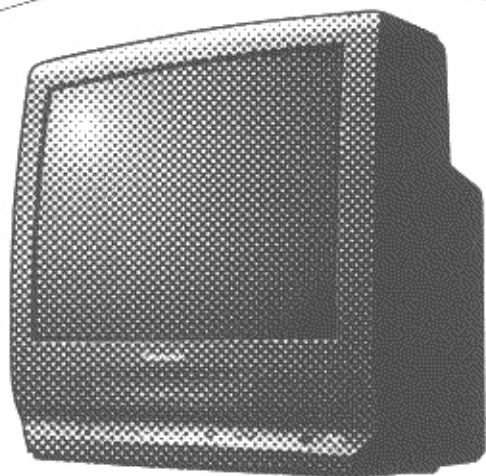

Combination VCR

**MODELS PV-M1348/PV-M1358W/  
PV-M1368/PV-M2038**

# Operating Instructions

Please read these instructions carefully before attempting to connect, operate or adjust this product. Please save this manual.  
Spanish Quick Use Guide is included.  
Guía para rápida consulta en español está incluido.

P2 ~ P10  
Getting Started

P11 ~ P15  
Basic TV Operation

P16 ~ P17  
Basic VCR Operation

P18 ~ P24  
More you Can Do

P25 ~ Back Cover  
Other Information

# Things You Should Know

## Congratulations

on your purchase of one of the most sophisticated and reliable products on the market today. Used properly, it will bring you and your family years of enjoyment. Please fill in the information at right. The serial number is on the tag located on the back of your Combination VCR.

Date of Purchase \_\_\_\_\_  
Dealer Purchased From \_\_\_\_\_  
Dealer Address \_\_\_\_\_  
Dealer Phone No. \_\_\_\_\_  
Model No. \_\_\_\_\_  
Serial No. \_\_\_\_\_

## Safety Precautions

**Warning: To prevent fire or shock hazard, do not expose this equipment to rain or moisture.**

This video recorder, equipped with the HQ (High Quality) System, is compatible with existing VHS equipment. Only use those tapes with the **VHS** mark. It is recommended that only cassette tapes that have been tested and inspected for use in 2, 4, 6, and 8 hour VCR machines be used.

This television receiver provides display of television closed captioning in accordance with §15.119 of the FCC rules.

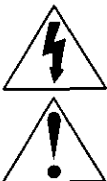
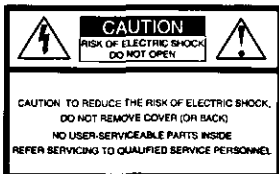

This symbol warns the user that uninsulated voltage within the unit may have sufficient magnitude to cause electric shock. Therefore, it is dangerous to make any kind of contact with any inside part of this unit.

This symbol alerts the user that important literature concerning the operation and maintenance of this unit has been included. Therefore, it should be read carefully in order to avoid any problems.

## Table of Contents

Things You Should Know .....	2
Important Safeguards and Precautions .....	3
Unpacking Your Combination VCR • Product Features.....	4

### Getting Started

Antenna or Cable Connections (Outdoor Antenna, Cable Box, Scrambled/Unscrambled Channels) .....	5
Location of Controls (Remote Control, Combination VCR) .....	6, 7
One Time Setup (On-Screen Language, Channel Memory, Auto Clock Set) .....	8, 9
On-Screen Displays (OSD) (Function, Channel, Menu, VCR Status/Clock, Warning, Instruction).....	10

### Basic TV Operation

TV Operation (Main Operation, Using the 100 key, Rapid Tune, Audio Mute, Phones, SELF-DEMO Mode, NITE/GAME mode).....	11
Picture Adjustment (Color, Tint, Brightness, Picture, Sharpness, Reset) .....	12
TV Timer Features (Alarm Timer, Sleep Timer) .....	13
Closed Caption System (Main Operation, Caption On Mute) .....	14
FM Radio .....	15

### Basic VCR Operation

Playback a Tape (Main Operation, Special Effects, Quality Picture Features) .....	16
Record On a Tape (Main Operation, One Touch Record, Input Select) .....	17

### More You Can Do

Timer Recording (Main Operation, Cancel, Clear or Replace Program Contents) .....	18, 19
Copying Your Tapes (Connection, Main Operation) .....	19
Special VCR Features (Channel Caption, Time Stamp, Blue Back ON/OFF, VCR Lock, Warning Beeper) .....	20, 21
Tape Operation (Index Search, Repeat Play, One Minute Skip, Zero Search, Auto Functions).....	22, 23, 24

### Other Information

Unit and Cassette Information .....	25
Before Requesting Service (Self-check Items) .....	26
Service Center List .....	27
Spanish Quick Use Guide/Guía para rápida consulta .....	28-31
Warranty.....	Back Cover

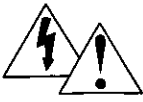

# Important Safeguards and Precautions

**FOR YOUR SAFETY, READ AND RETAIN ALL SAFETY AND OPERATING INSTRUCTIONS. HEED ALL WARNINGS IN THE MANUAL AND ON THE UNIT**

## INSTALLATION

### 1 POWER SOURCE CAUTION

Operate only from a power source indicated on the unit or in this manual. If necessary, have your Electric Utility Service Company or Video Products Dealer verify the power source in your home.

### 2 POLARIZED OR GROUNDING PLUG

As a safety feature, this Video product comes with either a polarized power cord plug (one blade is wider than the other), or a three-wire grounding type plug.

#### POLARIZED PLUG CAUTION:

This plug will only fit into an outlet one way. If you cannot fully insert the plug, try reversing it. If it still will not fit, have an electrician install the proper wall outlet. Do not defeat the safety feature by tampering with the plug.

#### GROUNDING PLUG CAUTION:

This plug will only fit into a three-hole grounding outlet. If necessary, have an electrician install the proper outlet. Do not defeat the safety feature by tampering with the plug.

### 3 POWER CORD

Make sure power cords are routed so that they are not likely to have anything rest on them, roll over them, or be in the way of walking traffic. If an extension cord is used, make sure it also has either a polarized or grounded plug and that the cords can be securely connected. Frayed cords, damaged plugs, and damaged or cracked wire insulation are hazardous and should be replaced by a qualified service technician. Overloaded outlets and extension cords are fire hazards and should be avoided.

### 4 DO NOT BLOCK VENTILATION HOLES

Ventilation openings in the cabinet release heat generated during operation. If they are blocked, heat build-up inside the unit can cause failures that may result in a fire hazard or heat damage to cassettes. For protection follow these rules:

- Never cover ventilation slots or the unit while in use, or operate the unit when placed on a bed, sofa, rug, or other soft surface.
- Avoid built-in installation, such as a book case or rack, unless proper ventilation is provided.

### 5 AVOID EXTREMELY HOT LOCATIONS OR SUDDEN TEMPERATURE CHANGES

Do not place the unit over or near any kind of heater or regulator, in direct sunlight, inside a closed vehicle, etc. Do not move the unit suddenly between areas of extreme temperature variation. If the unit is suddenly moved from a cold place to a warm place, moisture may condense in the unit and on the tape.

### 6 TO AVOID PERSONAL INJURY

- Do not place unsecured equipment on a sloping surface.
- Do not place this unit on any support that is not firm, level and adequately strong. The unit could fall causing serious injury to child or adult and damage to the unit.
- An appliance and cart combination should be moved with care. Quick stops, excessive force, and uneven surfaces may cause the appliance and cart combination to overturn.
- Carefully follow all operating instructions and use the manufacturer's recommended accessories when operating this unit or connecting it to any other equipment.



## OUTDOOR ANTENNA INSTALLATION

### 1 SAFE ANTENNA AND CABLE CONNECTION

If an outside antenna or cable system is connected to the equipment, be sure the antenna or cable system is grounded so as to provide some protection against built up static charges and voltage surges. Section 810 of the National Electrical Code, ANSI/NFPA 70 (in Canada, part 1 of the Canadian Electrical Code)

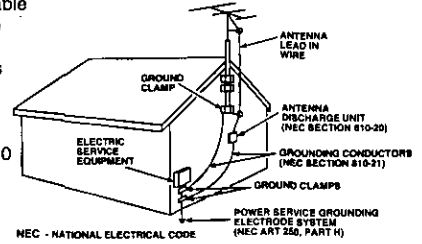

provides information with respect to proper grounding of the mast and supporting structure, grounding of the lead-in wire to an antenna discharge unit, size of grounding conductors, location of antenna discharge unit, connection to grounding electrodes and requirements for the grounding electrode.

### 2 KEEP ANTENNA CLEAR OF HIGH VOLTAGE POWER LINES OR CIRCUITS

An outside antenna system should be located well away from power lines, electric light or power circuits and where it will never come into contact with these power sources if it should happen to fall. When installing an outside antenna, extreme care should be taken to avoid touching power lines, circuits or other power sources as this could be fatal. Because of the hazards involved, antenna installation should be left to a professional.

## USING THE VIDEO UNIT

If the unit has been in storage or moved to a new location, refer first to the INSTALLATION section of these safeguards.

### 1 KEEP THIS VIDEO UNIT AWAY FROM WATER OR MOISTURE OF ANY KIND.

### 2 IF EQUIPMENT IS EXPOSED TO RAIN, MOISTURE, OR STRONG IMPACT, unplug the unit and have it inspected by a qualified service technician before use.

### 3 DURING AN ELECTRICAL STORM

During a lightning storm, whether indoors or outdoors, or before leaving the unit unused for extended periods of time, disconnect all equipment from the power source as well as the antenna and cable system.

### 4 WHEN THE UNIT IS PLUGGED IN

- Never expose the unit to rain or water. DO NOT OPERATE if liquid has been spilled into the unit. Immediately unplug the unit, and have it inspected by a service technician. Fire and shock hazards can result from electrical shorts caused by liquid contact inside.
- Never drop or press any object through openings in the unit. Some internal parts carry hazardous voltages and contact can cause electric shock or fire hazard.
- Avoid placing the unit directly above or below your TV set as this may cause electrical interference. Keep all magnets away from electronic equipment.

### 5 USING ACCESSORIES

Use only accessories recommended by the manufacturer to avoid risk of fire, shock, or other hazards.

### 6 CLEANING THE UNIT

Unplug the unit. Then, use a clean, dry, chemically untreated cloth to gently remove dust or debris. DO NOT USE cleaning fluids, aerosols, or forced air that could over-spray, or seep into the unit and cause electrical shock. Any substance such as wax, adhesive tape, etc. may mar the cabinet surface. Exposure to greasy, humid, or dusty areas may adversely affect internal parts.

## SERVICE

### 1 DO NOT SERVICE THIS PRODUCT YOURSELF

If, after carefully following the detailed operating instructions, this Video product does not operate properly, do not attempt to open or remove covers, or make any adjustments not described in the manual. Unplug the unit and contact a qualified service technician.

### 2 IF REPLACEMENT PARTS ARE REQUIRED

Make sure the service technician uses only parts specified by the manufacturer, or those having the same safety characteristics as the original parts. The use of unauthorized substitutes may result in fire, electric shock, or other hazards.

### 3 HAVE THE SERVICE TECHNICIAN PERFORM A SAFETY CHECK

After any service or repairs to the unit, request the service technician to conduct a thorough safety check as described in the manufacturer's service literature to insure that the video unit is in safe operating condition.

# Unpacking Your Combination VCR • Product Features

## Unpacking Your Combination VCR

The accessories shown below are provided to help you use or set up your Combination VCR.

### Accessories

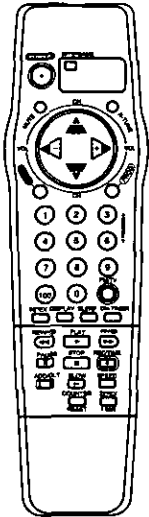

Remote Control  
 VSQS1563  
 (PV-M1348/PV-M1368/  
 PV-M2038)  
 VSQS1574  
 (PV-M1358W)

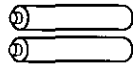

2 "AA" Batteries

To order accessories,  
 call toll free 1-800-211-PANA(7262).

## Load the batteries

**1** Press in and up on the latch with your thumb nail and lift off the lid.

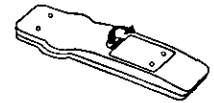

**2** Install two batteries as indicated inside the Battery Compartment.

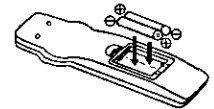

**3** Fit the lid's hinge piece into the indent on the case, and snap the lid into place.



### Battery replacement caution

- Do not mix old and new batteries.
- Do not mix alkaline with manganese batteries.

## Product Features

Alarm Timer .....	13
All Channel Auto Set/181-CH TV/CABLE Tuner .....	8
Auto Clock Set .....	8, 9
Auto Daylight Saving Time .....	25
Auto Operation Functions (Auto Shut Off, Auto Playback, Rewind, Tape Eject, Power Off) .....	24
Auto Repeat Function .....	24
Closed Caption System .....	14
Easy-to-Read English/Spanish/French On-Screen Displays .....	8, 9, 18, 19
FM Radio .....	15
Front-mounted A/V In Terminals .....	19
Head Cleaner <For Model PV-M2038 only> .....	25
NITE/GAME Mode .....	11
One Minute Skip .....	24
One Month, 8 Program Auto Timer Recording .....	18, 19
One Touch Recording (OTR) .....	17
PanaBlack™ Picture Tube <For Model PV-M2038 only> .....	16
Quick Play Mechanism .....	26
Rapid Tune .....	11
Special Effects Playback .....	16
Special VCR Features (Channel Caption, Time Stamp, Blue Back ON/OFF Feature, VCR Lock, Warning Beeper) .....	20, 21
VHS Index Search System (Direct Access Index Search, Program Index Search, Index Scan Search) .....	22, 23
Zero Search .....	24



# Antenna or Cable Connections

## Outdoor Antenna Connection

Unhook the antenna from your previous TV or VCR and connect it to the back of the Combination VCR as shown in the diagram. If your antenna system has separate UHF and VHF lead-ins, you need a UHF/VHF Band Mixer (not supplied).

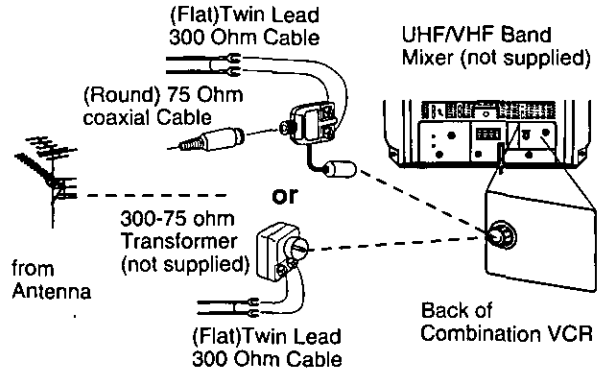

Model PV-M2038 unit is shown here.

## Cable Connections

### (A) Without a Converter/Descrambler Box

With this connection, you can use your Combination VCR remote control to select channels for viewing and select unscrambled channels for timer recording. Scrambled channels may not be viewed or recorded with this connection.

### (B) With a Converter/Descrambler Box

With this connection, you may record and view any channel including scrambled channels. Please note, however that channel selection must be made at the cable company converter box. Timer recording is limited to one channel at a time, and you can only view the channel you are recording.

### (A)

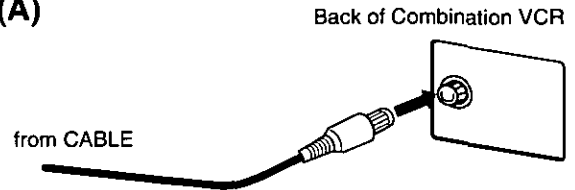

Model PV-M2038 unit is shown here.

### (B)

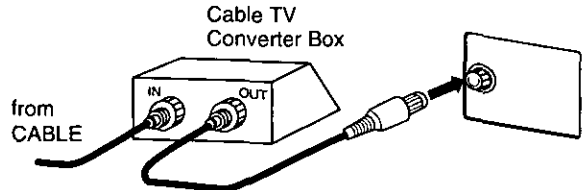

Model PV-M2038 unit is shown here.

## To Watch and Record Scrambled/Unscrambled Channels

Set the Combination VCR to the output channel of the cable converter box (e.g. CH3). Now, select channels to be viewed or recorded at the cable converter box.

**FCC WARNING:** Any unauthorized changes or modifications to this equipment would void the user's authority to operate.

### Note to CABLE System Installer

This reminder is provided to call the CABLE (Cable TV) System Installers attention to Article 820-40 of the NEC that provides guidelines for proper grounding and, in particular, specifies that the cable ground shall be connected to the grounding system of the building, as close to the point of cable entry as practical.



# Location of Controls

## Remote Control Buttons

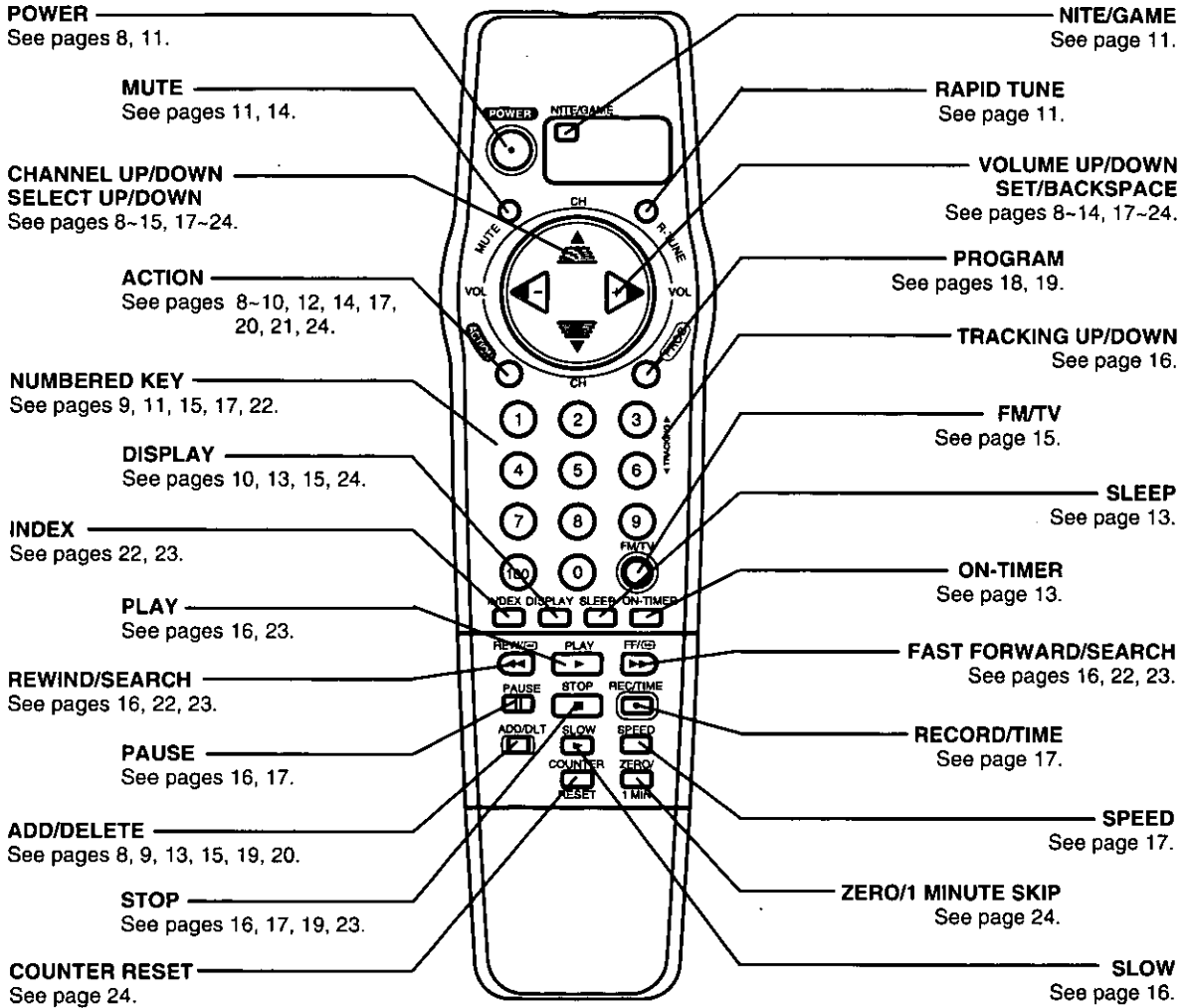

## Rear View of the Combination VCR

Models PV-M1348/PV-M1358W/PV-M1368 units are shown here.

**AC Power Plug**  
When plugged into an AC outlet, the Combination VCR consumes 5 W of electric power in OFF condition.

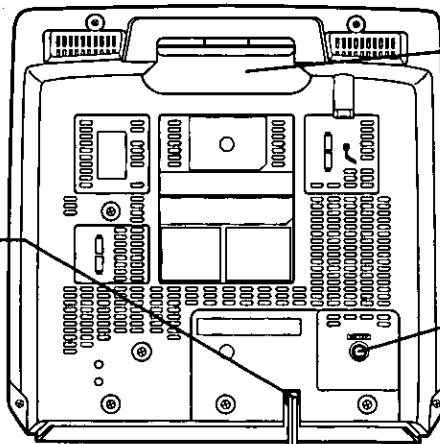

**Easy-Grip-Handle**  
<For Models PV-M1348/PV-M1358W/  
PV-M1368 only>  
Use when transporting the  
Combination VCR.

**VHF/UHF Antenna  
Input Terminal**  
In from your  
Antenna or Cable.  
See page 5.

## Front View of the Combination VCR

Model PV-M2038 unit is shown here.

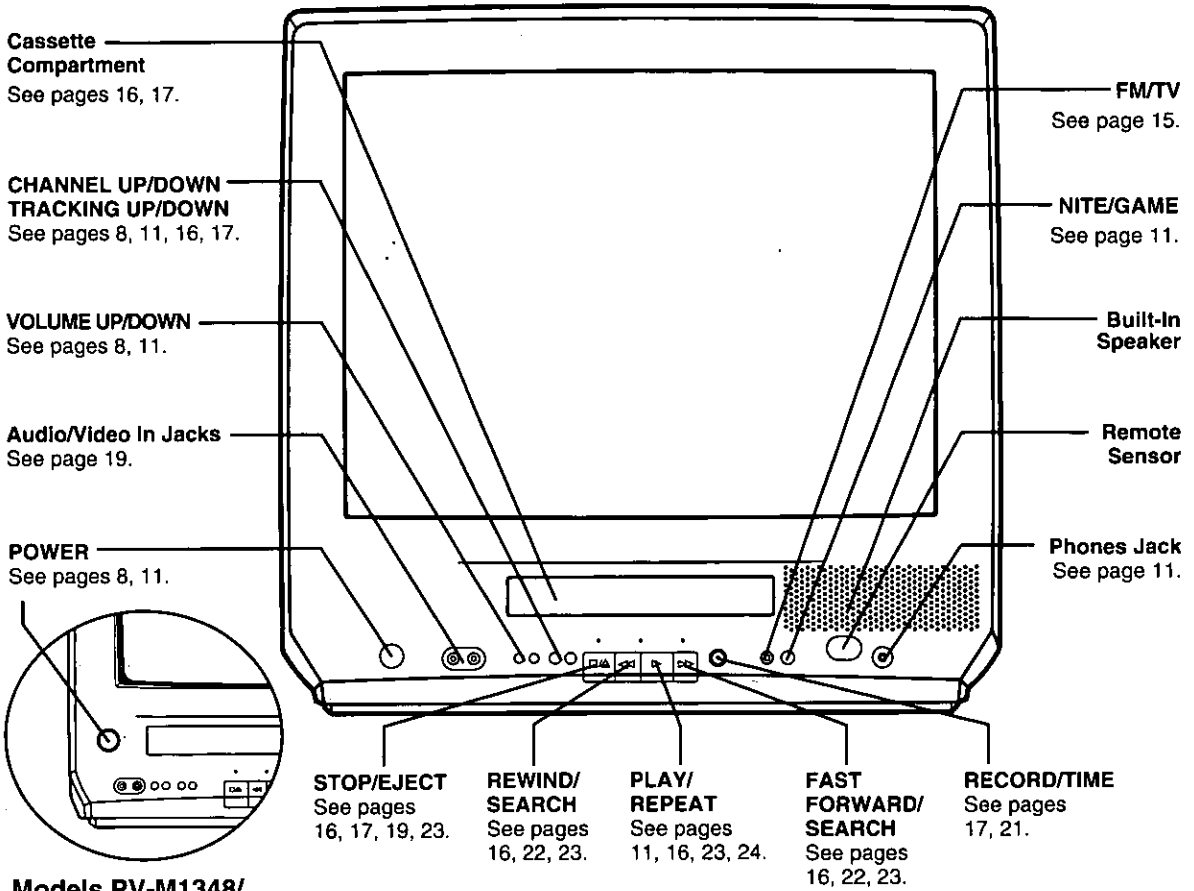

Models PV-M1348/  
PV-M1358W/PV-M1368  
units are shown here.

## Indicators on the Front Panel

Model PV-M2038 unit is shown here.

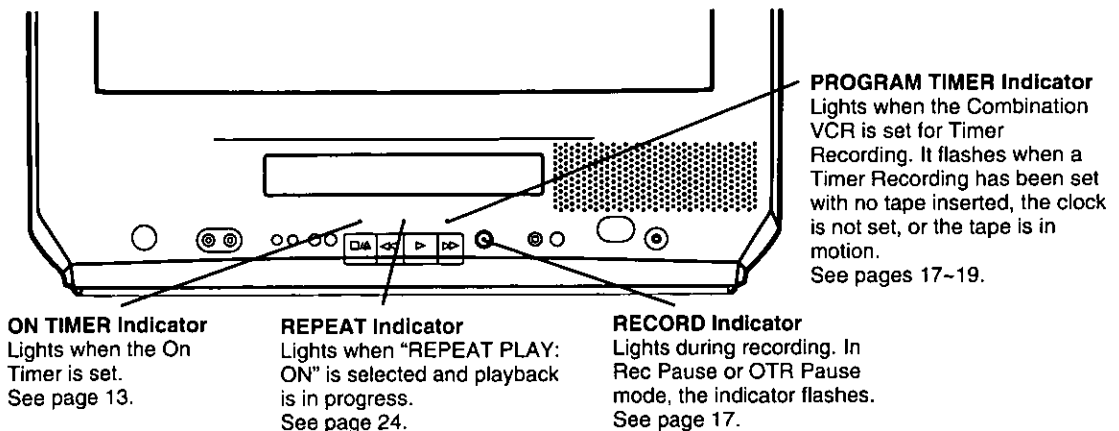



# One Time Setup

When the Combination VCR is turned on for the first time, it automatically enters the setup mode. Setup includes the following:

- Choose the language for on-screen menus and messages.
- Tell the Combination VCR how your equipment is hooked up (page 5) so the Combination VCR can correctly place channels into memory.
- Get the Combination VCR ready for clock set.



## Check list before you begin.

- Your Combination VCR is connected to an Antenna, or Cable system (see page 5).

Model PV-M2038 unit is shown here.

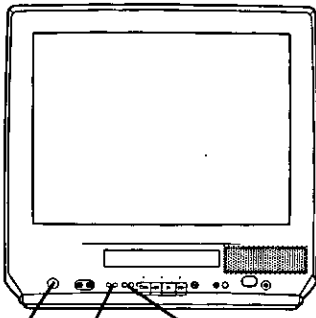

1 2 2-3 4

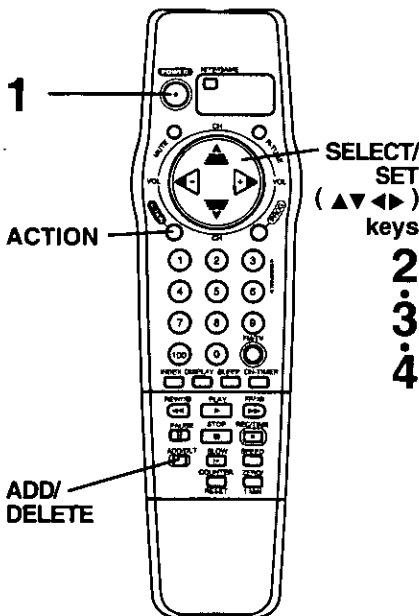

## Using the ▲▼◀▶ keys



Whenever a menu or program screen is displayed, CHANNEL UP/DOWN and VOLUME UP/DOWN on the remote control function as ▲▼◀▶ only. For VOLUME UP/DOWN functions, use the buttons on the Combination VCR.

## To Set Language, Channels and Clock

**1** Press **POWER** to turn the Combination VCR on.

**2** Press **CH ▲▼**, or **VOL ▶** for on screen displays in English, Spanish or French.

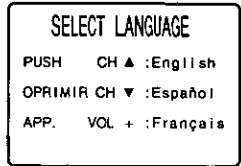

- If you choose the wrong language, please see the "Reset all Combination VCR Memory Functions" section on page 25.

- If you use a cable box, the cable box must be left on for auto channel set.

**Important:** If you use a cable box, turn it on and select the PBS station in your time zone.

**3** Press **CH ▲** to start Channel Auto Set and Clock Auto Set.

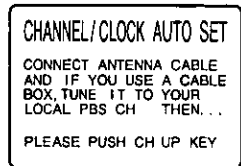

These on-screen displays will appear in sequence.

- CH AUTO SET PROCEEDING
- CH AUTO SET COMPLETED
- AUTO CLOCK SET PROCEEDING

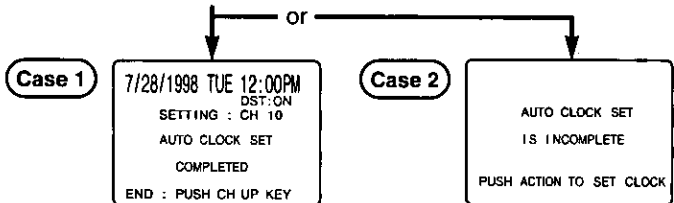

**4** **Case 1** If the displayed time is correct, press **CH ▲** to exit.

- This concludes one time Combination VCR setup.
- See important note at the bottom of this page.

**If the displayed time and DST. are not correct...**

If you happen to live close to two time zones, the Combination VCR may have recognized the PBS channel (setting channel) in the wrong time zone. Please do the following to correct the situation.

- Make a note of the SETTING: CH number shown on-screen and press **CH ▲** to exit.
- Delete the setting channel from the Combination VCR channel memory. (See the Add or Delete a Channel section on the next page.)
- Press **ACTION** to display the **MAIN MENU**.
- Press **▲▼◀▶** to select "CLOCK," and then press **ACTION** to display the **SET CLOCK** screen.
  - If you use a cable box and have multiple PBS stations, tune the cable box to a different PBS station and try auto clock set again using the menu.
- Press **▲▼** to select "AUTO CLOCK SET," and then press **▶** to set and **CH ▲** to start Auto Clock set.

### IMPORTANT NOTE FOR AUTO CLOCK SET

- Auto clock set will be performed when the Combination VCR is turned off the first time each day. If you use a cable box and you want auto clock set to be performed, the cable box must be left on and tuned to the PBS channel at the time the Combination VCR power is turned off.
- If you use Audio/Video Jack connection between the Combination VCR and Cable Box, you must also connect the RF coaxial cable in order to use the auto clock set and channel auto set features.
- If for any reason the time is changed manually, automatic time correction will not occur.



## Case 2 If AUTO CLOCK SET IS INCOMPLETE appears, please set the clock manually.

- Press ACTION to display the SET CLOCK screen.
- Press ▲▼ to select and ► to enter the month, date, year, time and DST. (Daylight Saving Time).

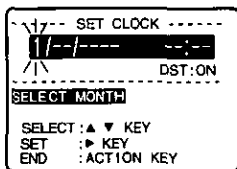

- To Make Corrections,** repeatedly press ◀▶ to move the cursor to the incorrect entry and make the correction.
- Press ACTION twice to start the clock and exit the MAIN MENU.

• "DST:ON" automatically adjusts for daylight saving time. (See page 25.)

## To Change the OSD Language

- Press ACTION to display the MAIN MENU.
- Press ▲▼◀▶ to select the language selection icon.
- Press ACTION repeatedly to change the language as shown.

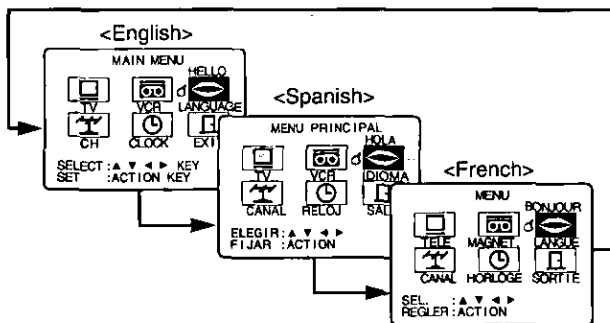

- Press ▲▼◀▶ to select "EXIT," and then press ACTION to exit the MAIN MENU.

## To Replace Channels in Memory

In case, you have cable installed, etc.

- Press ACTION to display the MAIN MENU.
- Press ▲▼◀▶ to select "CH," and then press ACTION to display the SET UP CHANNEL screen.
- Press ▲▼ repeatedly to select "ANTENNA," and then press ► to select your antenna system ("TV" or "CABLE").
- Press ▲▼ to select "AUTO SET," and then press ► to start.
  - To exit the SET UP CHANNEL screen, press ACTION twice.

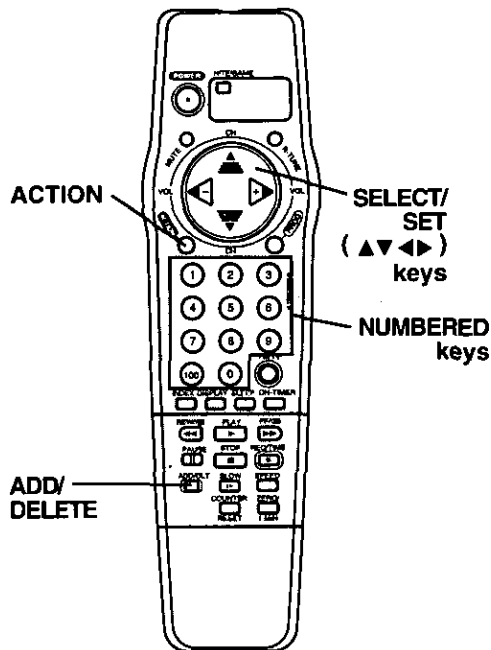
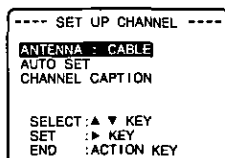
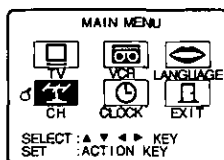

## To Set or Reset the Clock

In case the clock is wrong, or a power failure occurred.

- Press ACTION to display the MAIN MENU.
- Press ▲▼◀▶ to select "CLOCK." Then, press ACTION to display the SET CLOCK screen.
- Press ▲▼ to select "MANUAL," and then ► to display the SET CLOCK screen.
- Please do steps b and c at the top of this page.

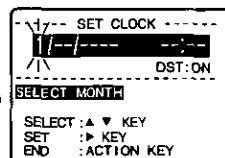
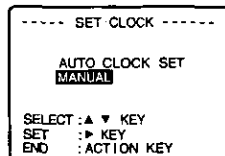

## To Add or Delete a Channel

- Select a channel using the NUMBERED keys to add or CH ▲▼ to delete.
- Press ADD/DEL to add or delete the channel.

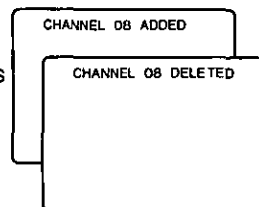

• To select a channel once it's deleted, use the NUMBERED keys.



- This Combination VCR will accurately maintain its calendar up to Dec. 31, 2089, 11:59PM.
- Normal TV or Cable channels are automatically selected and placed in memory depending on how your Combination VCR is hooked up.



# On-Screen Displays (OSD)

## Channel & Function Display

Whenever the channel is changed, the channel number will appear for a few seconds on-screen.

(Some station names may also appear if Channel Caption is set. See page 20.)

When a function button is pressed (PLAY, FF, etc.), the Combination VCR mode will be displayed.

- When a recording is started, both REC and the channel number will appear together.

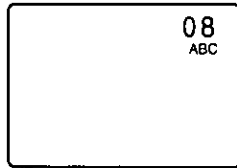

## Warning and Instruction Displays

These displays will alert you of a missed operation or provide further instructions.

If no active channels are found for CHANNEL MEMORY... (see page 5.)

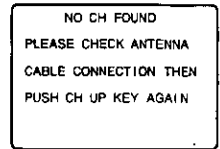

If you attempt to set or review a Timer Recording or set the On-Timer and the Clock is not set... (see pages 8, 9.)

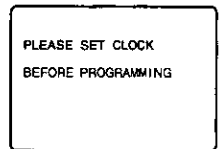

## Menu Screen

1 Press ACTION to display the MAIN MENU.

2 Press ▲▼◀▶ and ACTION to make your selection (see page 8).

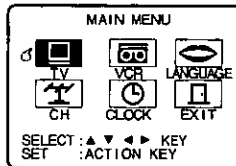

- To get the most from each feature, please read the Operation Manual before attempting any operation.

If you press REC on the remote control or the Combination VCR, and a cassette is inserted with no record tab... (see page 17.)

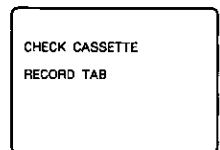

If you press STOP during a Timer Recording... (see page 19.)

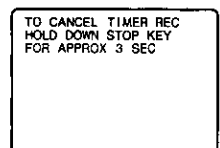

## VCR Status & Clock Display

Press DISPLAY to display and remove the overlay shown below.

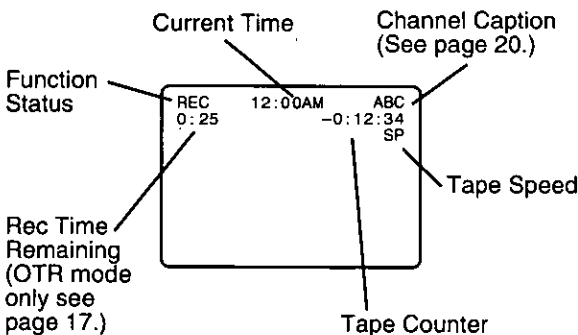

If you press PLAY, FF, REW, or REC on the remote control or the Combination VCR without a cassette inserted... (see pages 16, 17.)

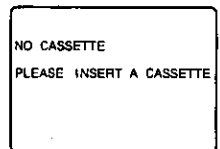

If the Combination VCR is not in Stop mode or a cassette with record tab is not inserted two minutes before a Timer Recording is about to begin... (see pages 18, 19.)



If head cleaning becomes necessary while playing back a tape... (see page 25.)

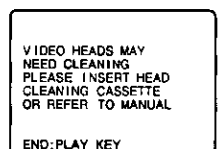

## Blank Tape/ No Video Signal Indication

Whenever a blank section of a tape comes up in Play mode, or when the selected channel has no broadcast signal with the "Blue Back ON/OFF Feature" (page 21) set to ON, the TV screen will turn solid blue.

If you press a function button other than STOP/EJECT or POWER while the Combination VCR is in VCR Lock mode... (See page 21.)

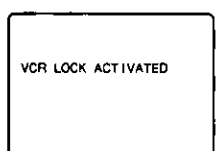



# TV Operation



Check list before you begin.

- All connections are made (see page 5).
- Your Combination VCR is plugged in.

Model PV-M2038 unit is shown here.

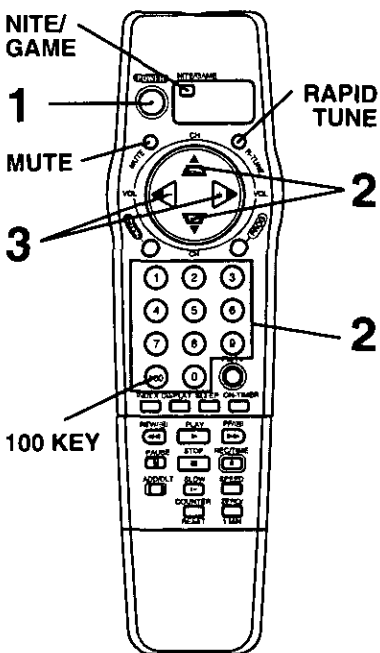
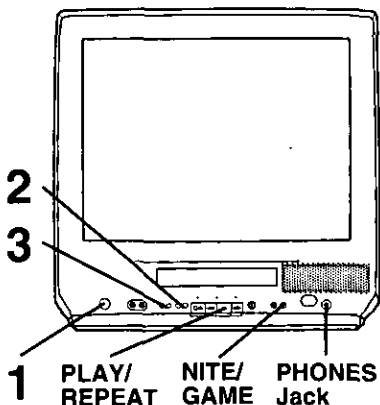

**1** Press **POWER** to turn the Combination VCR on.

**2** Select a channel using **CH ▲▼** or the **NUMBERED** keys.

**3** Press **VOL ◀▶** to adjust the volume level.

## Using the 100 key

When selecting CABLE channels 100 to 125 with the **NUMBERED** keys, first press the 100 key, and then enter the remaining two digits. For example, for channel 125: Press **NUMBERED** keys 100-2-5.

## Rapid Tune

Press **R-TUNE** to display the last channel you were watching.

- When selecting channels with **CH ▲▼**, the channels must be displayed for at least 4 seconds in order for the Combination VCR to recognize them as a new selection.



## Audio Mute

Press **MUTE** to instantly mute the sound. Press again, to restore the previous sound level.

## Phones

Connect an earphone (not supplied) or headphones (not supplied) to the Phones Jack.

## SELF-DEMO Mode

In Power ON condition, hold down **PLAY/REPEAT** on the Combination VCR, with no tape inserted, for 5 seconds. The demo screen appears. To cancel: Repeat the above operation. The demo screen disappears.

## NITE/GAME Mode Feature

This feature adjusts the color and picture intensity levels so the screen is easier on the eyes when watching a video or TV at night, or when playing video games.

Note: This Combination VCR contains no video game software.

Press **NITE/GAME** repeatedly to select the desired mode.

- "NITE" or "GAME" is displayed for 4 seconds.
- Each press of **NITE/GAME** will change the mode as shown below right.
- NITE mode may be selected when watching TV, playing a tape, or while in FM mode. GAME mode may only be selected when watching TV and playing video games.

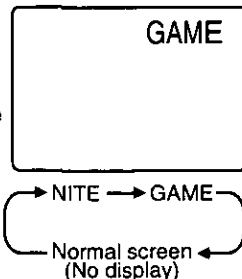

To Cancel the **NITE** or **GAME** mode, press **NITE/GAME** until the normal screen appears.

- The previous color and picture settings will be restored.



- **NITE** mode is cancelled when:
  - the power is turned Off
  - a power failure occurs
- **GAME** mode is cancelled when:
  - the power is turned Off
  - channel is changed
  - input signal is changed
  - play mode is entered
  - a power failure occurs
  - FM mode is selected





# TV Timer Features

## ✓ Check list before you begin.

- All connections are made (see page 5).
- Your Combination VCR is plugged in.

Model PV-M2038 unit is shown here.

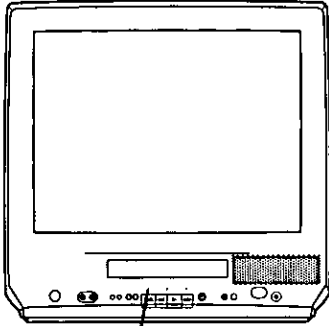

ON TIMER Indicator

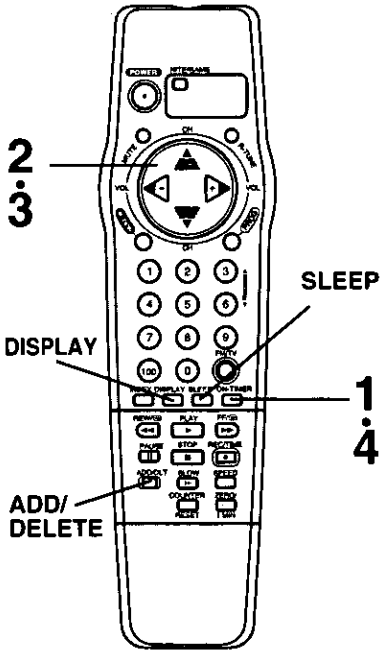

## On-Timer with Alarm Feature

The Combination VCR can be set to automatically power on in one of 3 modes (TV, Playback, or FM radio). You can also combine the On-Timer with a one minute alarm that gradually increases in volume.

**1** Press **ON-TIMER** to display the ON TIMER screen.

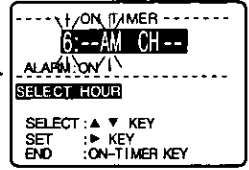

**2** Press **▲▼** to select and **▶** to fix the On-Timer time and also to choose the On-Timer mode (TV, PLAY, or FM radio). See the **▲▼** selection order shown below.

- Make sure a tape is inserted if Playback mode is selected.
- See "FM Radio Feature" on page 15 for instructions on how to preset FM stations.

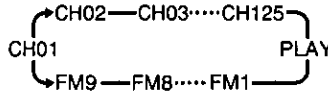

**3** Press **▲▼** to select alarm "ON" or "OFF."

When "ON" is selected, an alarm will gradually increase in volume for one minute or until cancelled by pressing any button on the remote or Combination VCR (including VOL **◀▶**). When the alarm sound stops, the sound of the mode you selected will ensue.

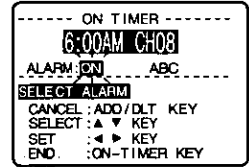

**To Make Corrections,** use **▲▼** and **◀▶** to move back and correct as necessary.

**4** Press **ON-TIMER** to set the On Timer. This screen will appear for about 5 seconds.

- The ON TIMER indicator lights on the front panel.

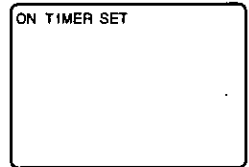

**To cancel,** press **ON-TIMER** to redisplay the screen in step 3. Then, press **ADD/DLT** to clear the time ("6" is flashing). Now, press **ON-TIMER** to end. "ON TIMER END" appears on-screen for a few seconds.



If no button on the remote or Combination VCR (including a button used to turn off the alarm) is pressed within 60 minutes after the Combination VCR turns itself on, it will turn itself back off.

## Set the Sleep Timer

The Combination VCR can be set for auto power off.

Press **SLEEP** repeatedly to set the sleep timer.

- Each press will change the time in the order shown at right.
- If you press **DISPLAY** with the **SLEEP TIMER** set, the remaining time will appear on-screen.

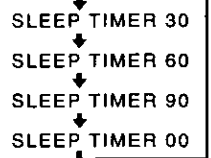

**To Cancel,** press **SLEEP** repeatedly until "SLEEP TIMER 00" appears.

# CC Closed Caption System

## ✓ Check list before you begin.

- All connections are made (see page 5).
- Your Combination VCR is plugged in.

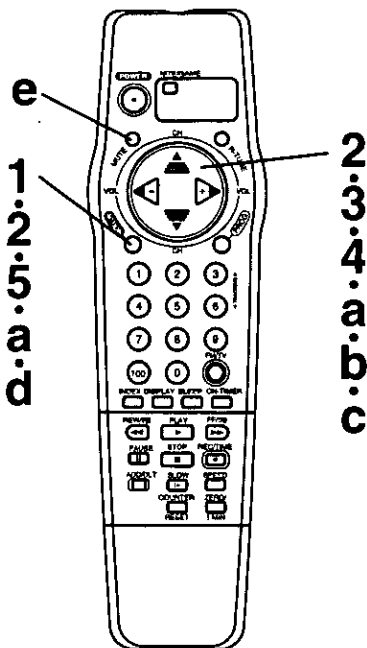

## Closed Caption Mode Feature

This multi-use system not only allows the hearing impaired to enjoy selected programs, but also makes useful information from TV stations available to everyone. At first, read through the different closed caption options below left.

**1** Press **ACTION** to display the **MAIN MENU**.

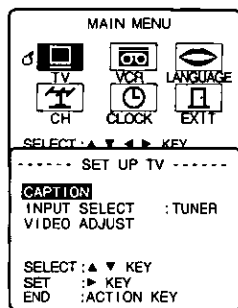

**2** Press **▲▼◀▶** to select "TV," and then press **ACTION** to display the **SET UP TV** screen.

**3** Press **▲▼** to select "CAPTION," and then press **▶** to display the **CAPTION** screen.

**4** Press **▲▼** to select "CAPTION MODE," and then press **▶** repeatedly to select the desired caption mode. (See "Caption Mode description" below left).

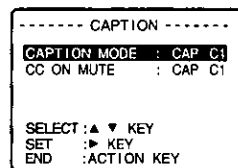

- Each press **▶** will change the display as shown at right.

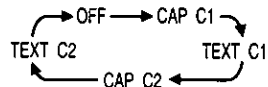

**5** Press **ACTION** three times to exit the caption mode and return to the normal screen.

## Closed Caption Modes From which to Choose

**Caption Mode: CAPTION C1 or C2**  
A narration of selected TV programs will be displayed on the screen. Check your TV program listings for C.C. (Closed Caption) broadcasts.

**Caption Mode: TEXT C1 or C2**  
The lower half of the screen will be blocked out. When the TV station broadcasts text, such as program listings, special information, etc., it will appear in this space.

**Caption Mode: OFF**  
Narration will not appear on the screen even if a closed caption or text broadcast is received.

**Note:** The closed caption or text signal may be broadcast over C1, C2, or both. Also, text contents can vary so you may wish to try different settings.

## Recording and Playing Back a Closed Caption/Text Program

**Record:** Your Combination VCR will automatically record the Closed Caption/Text signal. Just follow normal recording operation.

**Playback:** To display the Closed Caption narration or Text during playback, follow steps 1~3 in the above section, and then select the desired caption mode in step 4.

## Caption On Mute Feature

This feature allows you to turn off the sound and, at the same time, display Closed Caption narration. Perfect for when you need silence, but would like to continue watching the program.

**a** Follow steps 1~3 in the above section.

**b** In step 4, press **▶** to select "OFF."

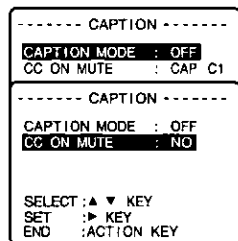

**c** Press **▲▼** to select "CC ON MUTE," and then press **▶** repeatedly to select the desired caption on mute mode.

- Each press of **▶** will change the display as shown at right.
- The caption may be broadcast over CAP C1 or C2.

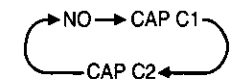

**d** Press **ACTION** three times to return to the normal screen.

**e** Press **MUTE** to mute the sound. The closed caption narration (if available) is displayed on the screen.

- Press **MUTE** again to resume normal sound and picture.



# FM Radio

The Combination VCR has an FM radio with built-in antenna, 9 station preset, and a band range of 87.5-108.1 MHz. You can even set the On-Timer (page 13) to wake up to your favorite music station.

## Check list before you begin.

- All connections are made (see page 5).
- Your Combination VCR is plugged in.

Model PV-M2038 unit is shown here.

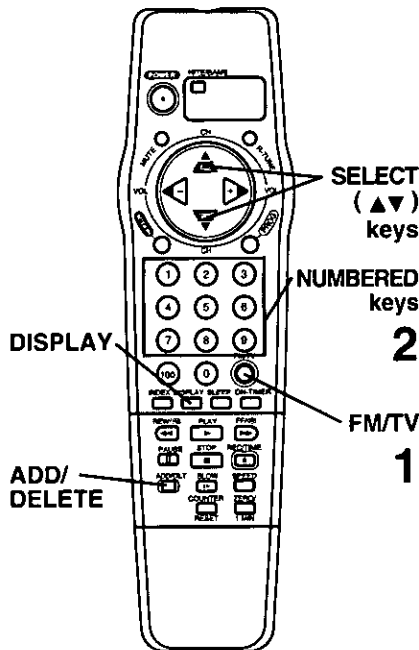
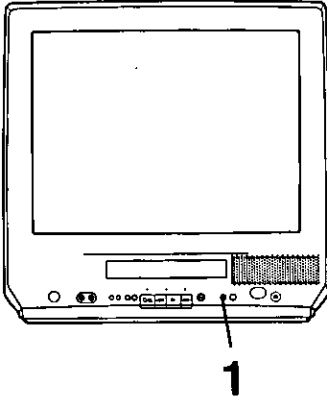

## FM Radio Feature Setup

- a Press FM/TV on the remote control or Combination VCR to select FM Radio mode.
- b In FM Radio mode, press a NUMBERED key (1-9).
- c Press ▲▼ to select the desired radio station. (Each press changes the frequency by 200 KHz.)

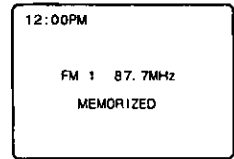
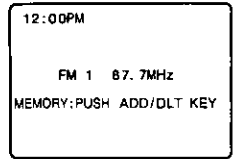
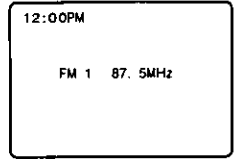

### Quick Station Scan

Hold down ▲ or ▼ for more than one second, and then release. The Combination VCR automatically advances the frequency 200KHz at a time.

When nearing the desired station, press ▲ or ▼ to select the station.

- d Press ADD/HLT to memorize the desired station.
  - To preset other stations, repeat steps b-d.

**To Make Corrections,** press the NUMBERED key to select the memorized number, and then repeat steps b-d to change the memorized station.

## Using the FM Radio

- 1 Press FM/TV on the remote control or Combination VCR to select FM Radio mode.

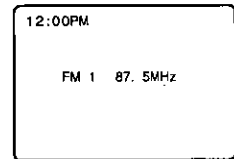

- 2 Press a NUMBERED key (1-9) to select a preset station (see steps a-d above).

Note: Once stations are preset, the selected station and current time will be displayed when FM/TV is pressed ON. After 10 seconds the station disappears. To remove the time, press DISPLAY. If DISPLAY is pressed while the station is still on screen or there is no display, the Combination VCR status screen appears.

**To cancel FM Radio mode,** press FM/TV again to return to the normal screen.



- If INDEX is pressed while in the FM radio mode, you will not be able to select other stations with the NUMBERED keys.
- You can not record FM radio stations onto a Video cassette tape.
- You may get improved FM reception for some stations by repositioning the Combination VCR.
- You can not select the FM Radio mode during playback or record, or while a blue back screen (ACTION, PROG, and ON-TIMER) is displayed.

# ▶ Playback a Tape

## ✓ Check list before you begin.

- All connections are made (see page 5).
- Your Combination VCR is plugged in.

Model PV-M2038 unit is shown here.

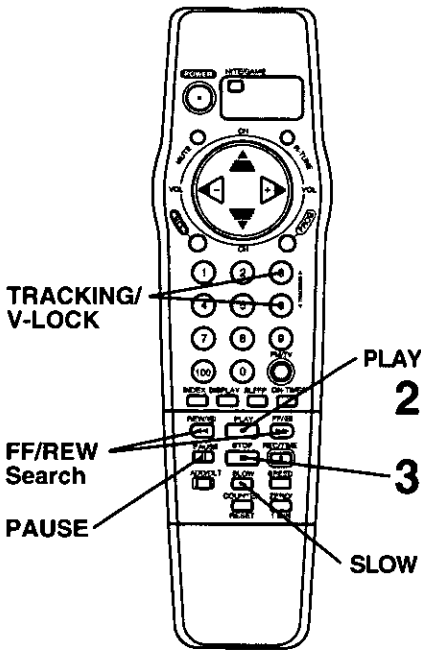
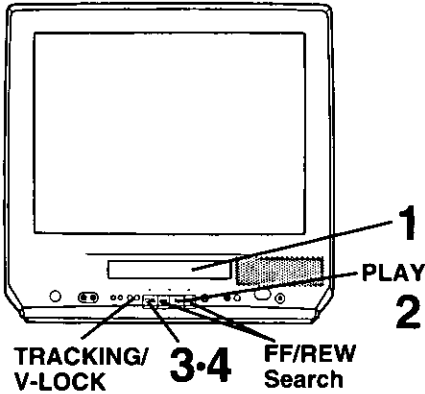

### Caution:

Please inspect your cassette tapes and remove any loose or peeling labels to prevent them from becoming jammed in your unit.

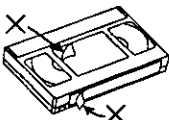

## 1 Insert a cassette.

- The Combination VCR power comes on automatically.

## 2 Press **PLAY** on the remote control or Combination VCR to start playback.

- Playback begins automatically if cassette has no record tab (see page 24).

## 3 Press **STOP** on the remote control or Combination VCR to stop playback.

- To rewind the tape, press **REW**.

## 4 Press **STOP/EJECT** on the Combination VCR to eject the cassette.

- You may eject a cassette with power on or off.

## To Find a Particular Scene During Playback

Press **REW** or **FF** on the remote control or Combination VCR to quickly locate a scene.

- Search speed for SP mode tapes is 7 times <For Model PV-M1368 only> and SLP mode tapes 21 times the normal speed.
- Some noise bars will appear during search.

## Special Effects During Playback

These features work best in SP <For Model PV-M1368 only> or SLP mode. The sound will be muted.

### Slow Motion Playback

Press **SLOW** to start slow motion playback. Press **PLAY** or **SLOW** to release.

### Still (Freeze) Frame Picture

Press **PAUSE** to freeze and release the picture.

- To reduce picture noise, first press **SLOW**. Next, use the 3 or 6 **NUMBERED** key on the remote control or **CH ▲▼** on the Combination VCR to clear up the picture. Now, press **PAUSE**.

### Frame by Frame Advance

While in Still mode, press **SLOW** repeatedly or hold down to advance the still picture one frame at a time. Press **PAUSE** or **PLAY** to release.

(After the Combination VCR is in Still or Slow mode for 3 minutes, it will switch to the Stop mode automatically to protect the tape and the video head.)

## Features for a Quality Picture

### Digital Auto Tracking

This feature continuously analyzes the signal and adjusts for optimum picture quality.

### Manual Tracking Control

Use during Playback and Slow Motion mode to reduce picture noise. Press the 3 or 6 **NUMBERED** key on the remote control or **CH ▲▼** on the Combination VCR until the picture clears up. To return to Auto Tracking, press **POWER** off and then on again.

### V-Lock Control <For Model PV-M1368 only>

In Still mode, the 3 or 6 **NUMBERED** key on the remote control or **CH ▲▼** on the Combination VCR operate as a V-Lock control to reduce jitter. Press one of these keys until the picture is stabilized.

### PanaBlack™ Picture Tube <For Model PV-M2038 only>

This Combination VCR uses a PanaBlack™ picture tube for better color reproduction and picture contrast.





# Record On a Tape

## ✓ Check list before you begin.

- All connections are made (see page 5).
- Your Combination VCR is plugged in.

Model PV-M2038 unit is shown here.

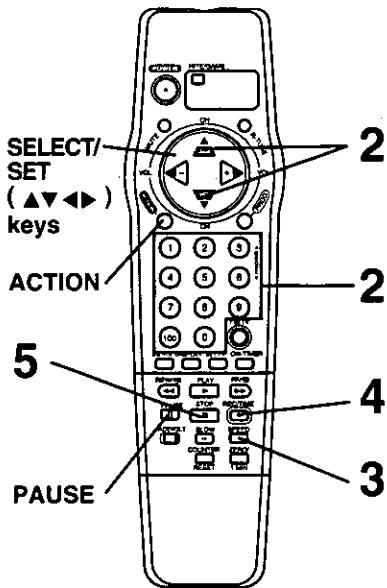
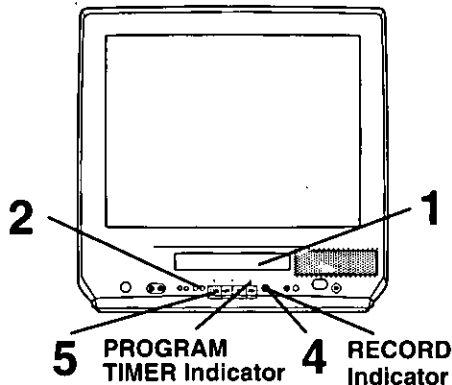

## Selecting the Input Mode

You can select the Input Mode in either of the following ways.

- Press CH ▲▼. The display will change in the order below.

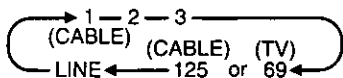

- a Press ACTION to display the MAIN MENU.
- b Press ▲▼◀▶ to select "TV," and then press ACTION to display the SET UP TV screen.
- c Press ▲▼ to select "INPUT SELECT," and then press ▶ repeatedly to select "TUNER" or "LINE."

## 1 Insert a cassette with record tab.

- The Combination VCR power comes on automatically.

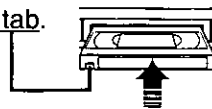

## 2 Press CH ▲▼, or NUMBERED keys on the remote control to select a channel.

- Or, press CH ▲▼ on the Combination VCR.
- To record from an outside source, press CH ▲▼ to select LINE input (see bottom of this page).

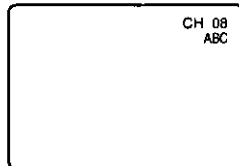

## 3 Press SPEED repeatedly until the desired tape speed is displayed (see page 25).

- SP = Standard Play
- LP = Long Play
- SLP = Super Long Play

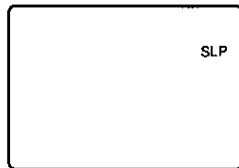

## 4 Press REC/TIME on the remote control to start recording.

- Or, press REC/TIME on the Combination VCR.
- To edit out unwanted portions, press PAUSE to pause the recording in progress. To release, press PAUSE again.
- You can not view another channel during recording.

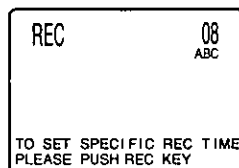

## One Touch Timer Recording (OTR)

The Combination VCR stops recording at a preset time. In step 4, press REC/TIME repeatedly to set the length of the recording. Each press will change the time as shown.

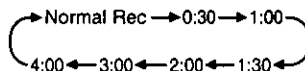

- The PROGRAM TIMER indicator lights on the front panel.

## 5 Press STOP on the remote control to stop recording.

- Or, press STOP/EJECT on the Combination VCR.



- While it is possible to change the tape speed when you are recording, there will be some distortion on the tape where the change occurred.
- The remaining recording time of an OTR can be displayed by pressing DISPLAY.
- After the Combination VCR has been in Rec Pause mode for 5 minutes, it will stop automatically to protect the tape and video head.



# Timer Recording

Your Combination VCR can be set up to do a recording while you are away or otherwise occupied. Up to 8 programs can be placed in memory. You can choose to record one time, daily, or weekly.

## ✓ Check list before you begin.

- All connections are made (see page 5).
- Your Combination VCR is plugged in.
- The clock is set.
- The tape is long enough.
- The record tab is in place.

Model PV-M2038 unit is shown here.

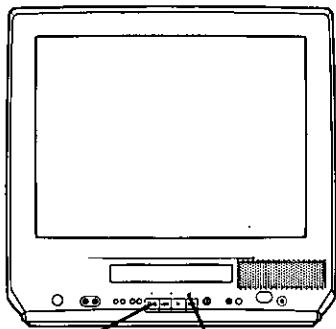

STOP/EJECT      PROGRAM TIMER Indicator

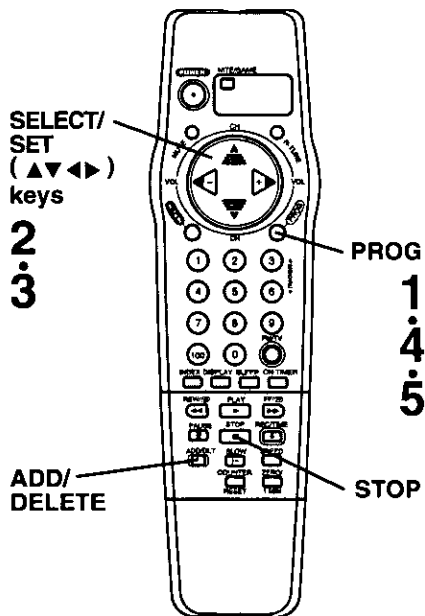

## 1 Press PROG to display the SET PROGRAM screen.

- If a program is already in memory, press ▲▼ repeatedly, and then ► to select an unused program number.

DATE /	START	STOP	CH
7 FRI	--:--	--:--	--
TODAY			
CATEGORY: N/A			
SLP			
-----			
SELECT START DATE			
SELECT: ▲ ▼ KEY			
SET: ► KEY			
END: :PROG KEY			

## 2 Press ▲▼ and ► to select and set one of the following as the DATE:

- 1~31 = One time recording
- DAILY = Same time MON ~ FRI
- WEEKLY SUN-SAT = Same time once a week

### Example

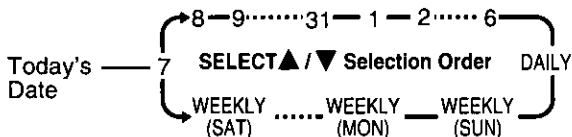

## 3 Press ▲▼ and ► to select and set each of the remaining items as follows.

### Remaining Items:

- START time
- STOP time
- CH(annel) number, or LINE for outside source recording
- Category [N/A (not applicable), SPORTS, MOVIE, COMEDY, MUSIC, DRAMA]
- Speed (SP, LP, SLP)

### To Make Corrections

Repeatedly press ► or ◀ to move the cursor to the right or left, and then make the correction.

## 4 Press PROG to end the program.

- This screen appears for confirmation.

P	DT	START	STOP	CH	SPD
1	day	9:00a	12:00a	08	SP
2	--	--	--	--	--
3	--	--	--	--	--
4	--	--	--	--	--
CANCEL: ADD/DLT KEY					
SELECT 1-8: ▲ ▼ KEY					
ENTER: ► KEY					
END: :PROG KEY					

### To Enter More Programs

Press ▲▼ and ► to select and set a blank program number, and then repeat steps 2 and 3.

## 5 Press PROG to exit this mode and return to the normal screen.

- The PROGRAM TIMER indicator lights on the front panel.
- If you're using a cable box, make sure that it is tuned to the desired channel and the power is left on for timer recording.

Two minutes before the Timer Recording starts, "TIMER REC WILL START SOON" will appear on-screen.

## NOTES

- If "PLEASE PREPARE FOR TIMER REC" appears and/or the PROGRAM TIMER indicator flashes, check that a cassette with record tab is loaded and the Combination VCR is in Stop mode.
- If the start times of two programs overlap, the lower numbered program will have priority.
- If the start time for a timer recording comes up during a normal recording or One Touch Recording (page 17), the timer recording will not be performed.
- If there is a power interruption of more than one minute, the recording may not be performed or continue.
- If "INCOMPLETE" appears after all items have been set, check all entries and make necessary corrections.



# Copying Your Tapes (Dubbing)

## Cancel a Timer Recording: (Recording is in progress)

Hold down STOP for a few seconds to cancel the Timer Recording.

- Any future daily or weekly recordings will be performed as programmed.

## Replace Program Contents: (Recording is not in progress)

1 Do step 1 on previous page. All currently set programs will be displayed on-screen.

2 Press ▲▼ repeatedly to select the desired program, and then press ► to display the settings. (See page 18.)

P	DT	START	STOP	CH	SPD
1	--	--	--	--	--
2	8	10:00p	12:00p	125	SP
3	10	8:00p	9:00p	10	SP
4	SU	9:00p	10:00p	L	LP

SELECT 1-8: ▲▼ KEY  
ENTER : ► KEY  
END : PROG KEY

3 Press ▲▼ repeatedly to select, and then press ► to enter replacement information.

DATE/	START	STOP	CH
8 SAT	10:00p	12:00p	102
TODAY			
CATEGORY:SPORTS		CBS	
SP		SP	
SELECT START DATE			
SELECT: ▲▼ KEY			
SET : ◀▶ KEY			
END : PROG KEY			

4 Press PROG twice to exit this mode and return to the normal TV screen.

## Review or Clear Program Contents: (Recording is not in progress)

a Do step 1 on previous page. All currently set programs will be displayed on-screen.

P	DT	START	STOP	CH	SPD
1	day	9:00a	12:00a	08	SP
2	8	10:00p	12:00p	125	SP
3	10	8:00p	9:00p	10	SP
4	SU	9:00p	10:00p	L	LP

CANCEL: ADD/HLT KEY  
SELECT 1-8: ▲▼ KEY  
ENTER : ► KEY  
END : PROG KEY

b Press ▲▼ repeatedly to select the desired program number.

P	DT	START	STOP	CH	SPD
1	--	--	--	--	--
2	8	10:00p	12:00p	125	SP
3	10	8:00p	9:00p	10	SP
4	SU	9:00p	10:00p	L	LP

SELECT 1-8: ▲▼ KEY  
ENTER : ► KEY  
END : PROG KEY

c Press the ADD/HLT if you want to clear the program.

d Press PROG to exit this mode and return to the normal TV screen.

## Connections you'll need to make.

- Use this same connection for your video camera, laser disc player, video games, etc.

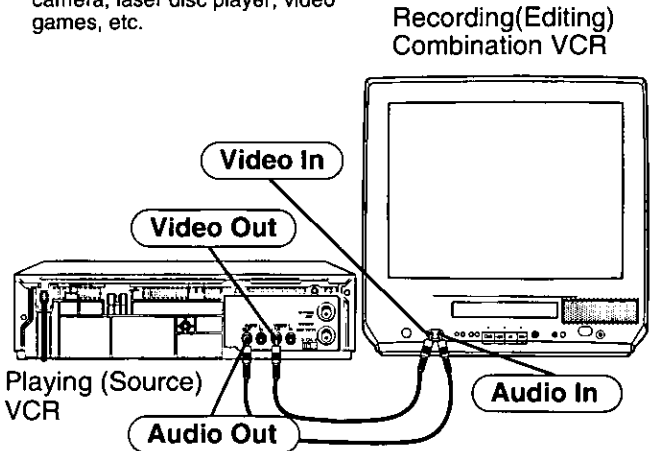

Model PV-M2038 unit is shown here.

1 Insert a pre-recorded tape into the Playing (source) VCR.

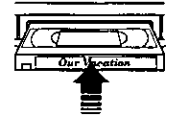

2 Insert a blank tape with record tab into the Recording (editing) Combination VCR.

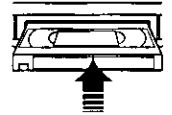

3 Select "LINE" as the input on the Combination VCR.

- See "Selecting the Input Mode" section on page 17.

4 Press PLAY on the VCR. Then, press PAUSE when the tape reaches the point at which you want to start copying.

5 Press REC on the Combination VCR, and then immediately press PAUSE on the remote control.

6 Press PAUSE on both units at the same time to begin copying.

You can edit out unwanted parts of the original recording by using PAUSE (on the Recording unit) while copying is in progress.

7 Press STOP on both units to stop copying.

### Caution:

Unauthorized exchanging and/or copying of copyrighted recordings may be copyright infringement.

## Channel Caption

You can set channel names, i.e. ABC, CBS, so that when selected, the channel name and number appear on-screen for easy identification. You can go with preset names (up to 24), or manually create your own (up to 10).

Note: You will need a list of channels received in your area and the channel numbers you receive them on.

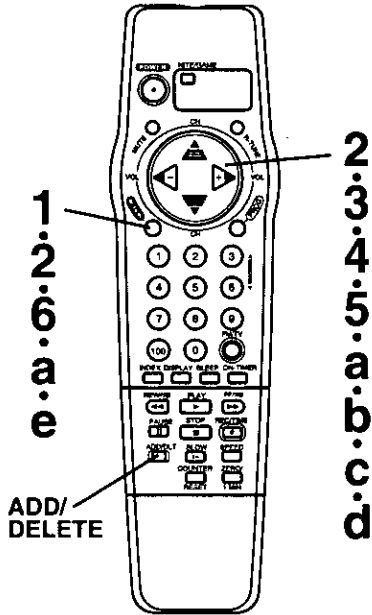

## Preset Caption

**1** Press **ACTION** to display the MAIN MENU.

**2** Press **▲▼◀▶** to select "CH," and then press **ACTION** to display the SET UP CHANNEL screen.

**3** Press **▲▼** to select "CHANNEL CAPTION," and then press **▶** to display the CHANNEL CAPTION screen.

**4** Press **▲▼** to select "PRESET CAPTION," and then press **▶** to display the PRESET CAPTION screen.

• You can set up to twenty-four channel captions. If you want to set a station name other than these, go to the "Manual Caption" section below.

**5** Press **▶** to move the shaded area to the right side.

Then, press **▲▼** to change the memorized channel number to match the caption.

Next, press **◀** to set the memorized channel number.

Now, press **▲▼** to continue.

Repeat step 5 until the Caption List is complete.

### To Make Corrections

Press **▲▼** and **▶** to select the memorized channel number. Then, press **▲▼** to change, or ADD/DLT to delete the memorized channel number.

**6** Press **ACTION** four times to exit this mode and return to the normal screen.

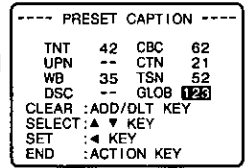
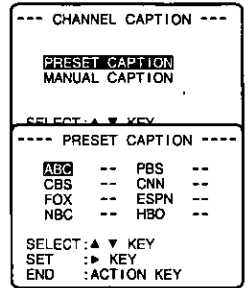
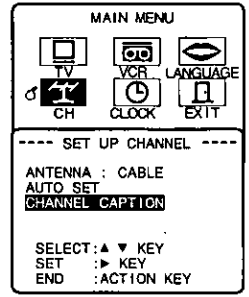

## Manual Caption

**a** Follow steps 1~3 in the above section.

**b** In step 4, press **▲▼** to select "MANUAL CAPTION," and then press **▶** to display the MANUAL CAPTION screen.

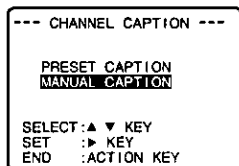

**c** Press **▲▼** to select "CH NUMBER," and then press **▶** to move the shaded area to the right side.

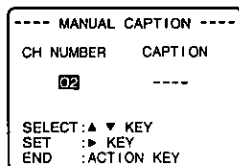

• Channels already set in the "Preset Caption" section are not displayed.  
• You can set a total of ten channel captions with up to four characters each.

**d** Press **▲▼** to select, and then press **▶** to enter each character of the caption.

• Characters will change in the following order.

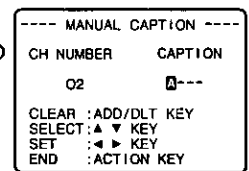
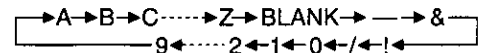

Now, press **◀** repeatedly to move the cursor back to "CH NUMBER." Repeat steps **c~d** as desired.

To Make Corrections, repeatedly press **▶** to move the cursor to the right, or **◀** to move to the left to the incorrect entry and make the correction.

To Clear the caption, press ADD/DLT.

**e** Press **ACTION** four times to exit this mode and return to the normal screen.

Check list before you begin.

The clock is set to correct time.

Model PV-M2038 unit is shown here.

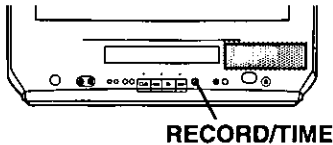

RECORD/TIME

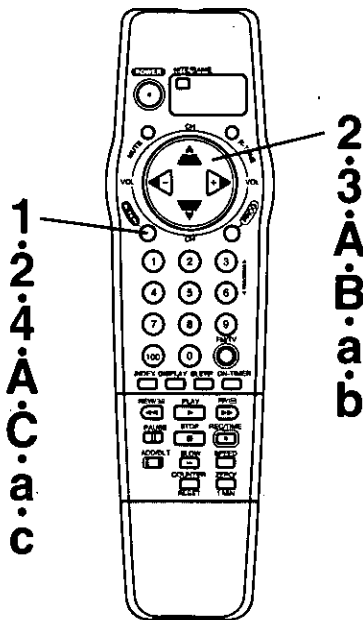

## Time Stamp Feature

For about the first 10 seconds of each recording, the Combination VCR automatically writes the following program data on the tape: Date, Start time, Scheduled stop time (for Timer Rec. only), Channel No., and Category (for Timer Rec. only). Then, if playback is started at the starting point of the recording, this information will be displayed about 7 seconds after playback begins for a few seconds.

**1** Press ACTION to display the MAIN MENU.

**2** Press ▲▼◀▶ to select "VCR," and then press ACTION to display the SET UP VCR screen.

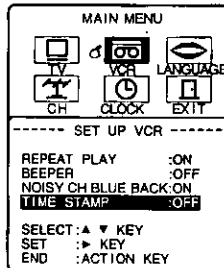

**3** Press ▲▼ to select "TIME STAMP," and then press ▶ to select "ON" or "OFF."

• When "OFF" is selected, the program data is written on the tape, but will not be displayed for the first 5 seconds of playback.

**4** Press ACTION twice to return to the normal screen.

### <Time Stamp Example >

Normal/One Touch Recording	Timer Recording	When Clock is not set...
12/28/1998 MON 12:00PM CH 08 ABC	12/28/1998 MON 12:00PM - 1:00PM CH 08 ABC SPORTS	----- ----- CH 08 ABC

• If the tape speed is changed immediately after recording begins, the display may be incorrect.

## VCR Lock Feature

When activated, this feature prohibits all operations except for timer recording and tape eject. This feature may be used to keep young children from operating the Combination VCR.

Hold down REC/TIME on the Combination VCR without a cassette inserted for 7 seconds during Power On mode.

• "NO CASSETTE PLEASE INSERT A CASSETTE" is displayed when REC/TIME is pressed. Please disregard this warning and continue to hold down REC/TIME for 7 seconds.

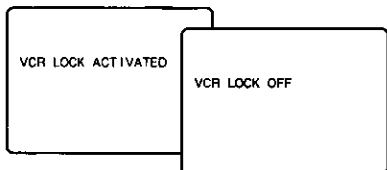

To Cancel the VCR Lock feature, with or without a cassette inserted, hold down REC/TIME on the Combination VCR for 7 seconds again during Power On mode.

• VCR Lock mode is cancelled automatically after about 24 hours as long as the clock is set.

## Blue Back ON/OFF Feature

You may choose whether or not you want the Combination VCR to display a solid blue back screen when the broadcast signal is very weak or the playback signal is not present.

**A** Follow steps 1-2 in the above section.

**B** Press ▲▼ to select "NOISY CH BLUE BACK," and then press ▶ to select "ON" or "OFF."

• When "ON" is selected, a solid blue screen appears whenever the signal is weak or nonexistent. When "OFF" is selected, the picture is displayed regardless of the signal condition.

• The picture cannot always be seen clearly when OFF is selected.

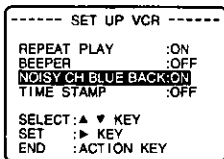

**C** Press ACTION twice to return to the normal screen.

## Warning Beeper Feature

When you select BEEPER ON, a short warning will sound each time an invalid entry or incomplete operation is made.

**a** Follow steps 1-2 in the above section.

**b** Press ▲▼ to select "BEEPER," and then press ▶ to select "ON" or "OFF."

**C** Press ACTION twice to exit this screen.

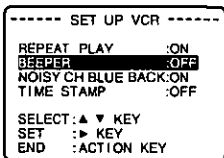

More you Can Do



# Tape Operation

## VHS Index Search System

Each time you start a recording, an invisible index mark is placed on the tape. When timer recordings are made, program index and program information (see "Time Stamp Feature" on page 21) are also included. You can then use these index marks to access or scan your recordings.

Model PV-M2038 unit is shown here.

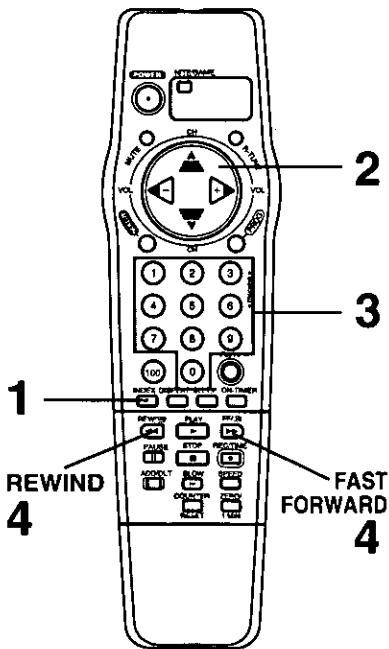
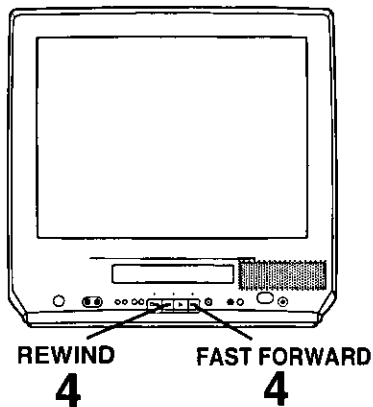

## Direct Access Index Search (For normal and/or timer recordings.)

This feature allows you to go directly to the recording you want from anywhere on the tape by entering the appropriate index number.

**1** Press **INDEX** in Playback or Stop mode to display the INDEX screen.

- This screen appears only if there are timer recordings on the Program Index list. If this screen does not appear, go to step 3.

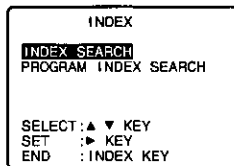

**2** Press **▲▼** to select "INDEX SEARCH," and then press **▶** to display the INDEX screen.

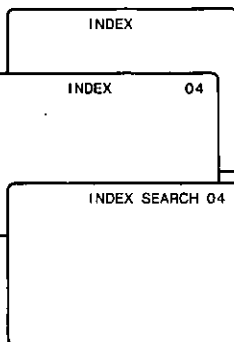

**3** Press a **NUMBERED** key to select the desired recording.

- To calculate the number, see below.

**4** Press **REW** or **FF** to start a reverse or forward search.

- When the designated location is reached, the Combination VCR goes into Playback mode.

### To calculate the Index Number

Count forward or backward each recording start point, including the recording you want to see, from wherever you are on the tape.

#### Example 1:

If you are watching recording 4 and you want to watch recording 2, count the start points to number 2. The total is 3. Enter 3 in step "3" and press REW.

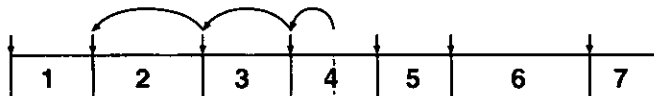

#### Example 2:

If you are watching recording 2 and you want to watch recording 6, count the start points to number 6. The total is 4. Enter 4 in step "3" and press FF.

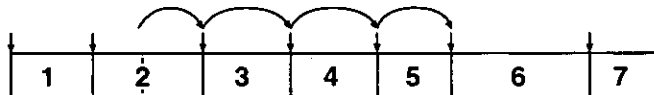

NOTE: ↓ indicates start points of each recording.



- Make each entry within 10 seconds, or the Index Search mode will be cancelled.
- If any of the VHS Index Search System features are initiated extremely close to an index mark, the index mark may not be counted in the search.
- In the Program Index Search mode, this Combination VCR can memorize a total of 8 programs in order of recording. If you memorize more than 8 programs, the first program will be deleted and the new program will be listed.

Timer recordings must be recorded back to back in order for them to be placed on the Program Index list. If a timer recording is followed by a function, such as REW or PLAY the data is lost.

Model PV-M2038 unit is shown here.

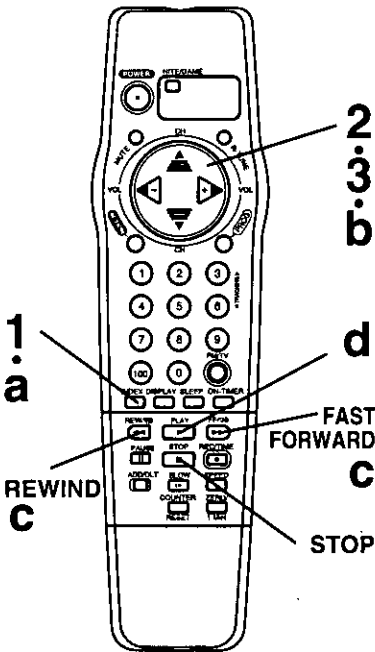
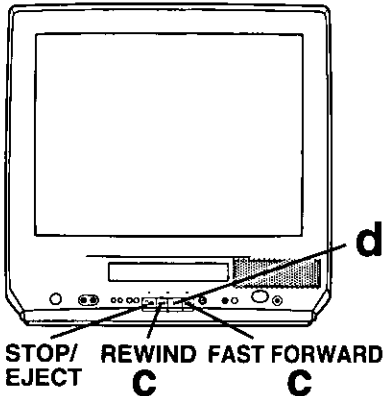

## Program Index Search (For timer recordings only.)

This feature allows you to choose a timer recorded program from a Program Index list, and then start a search for that program.

- Once a tape is ejected or normal recording is started, all program index data is erased.

**1** Press INDEX in Playback or Stop mode to display the INDEX screen.

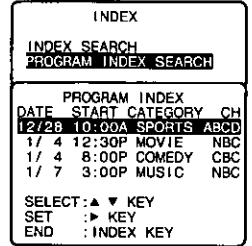

**2** Press ▲▼ to select "PROGRAM INDEX SEARCH," and then press ► to display the PROGRAM INDEX screen.

**3** Press ▲▼ to select the desired recorded program, and then press ► to start the forward or rewind search.

- When the designated program is reached, the Combination VCR automatically goes into Playback mode.

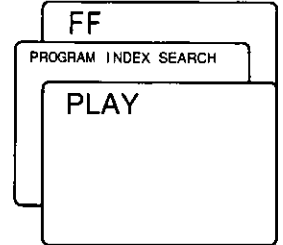

## Index Scan

(For normal and/or timer recordings.)

This feature allows you to scan (forward or reverse) each recording for 10 seconds in Playback mode.

**a** Press INDEX in Playback or Stop mode to display the INDEX screen.

- This screen appears only if there are timer recordings on the Program Index list. If this screen does not appear, go to step c.

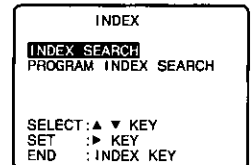

**b** Press ▲▼ to select "INDEX SEARCH," and then press ► to display the INDEX screen.

**c** Press REW or FF to begin the scan.

- As each index mark is reached, a short playback will be performed after which FF or REW resumes.

**d** Press PLAY to cancel the scan and begin playback.

- You may also press STOP to stop the tape.

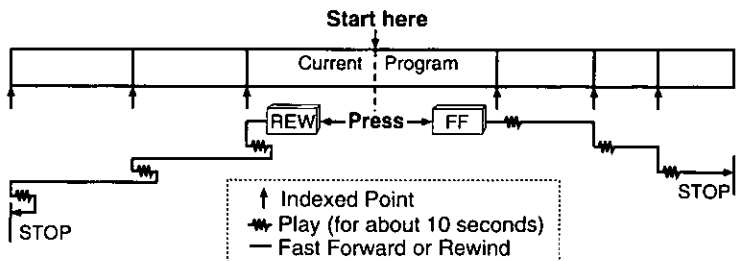
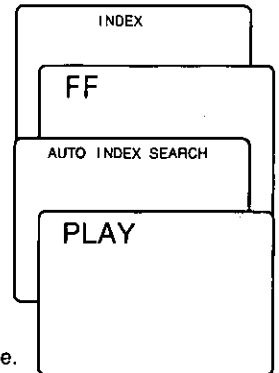

More you Can Do



# Tape Operation (continued)

Your Combination VCR is equipped with several time saving features as well as convenient automatic functions which make tape operation easier than ever.

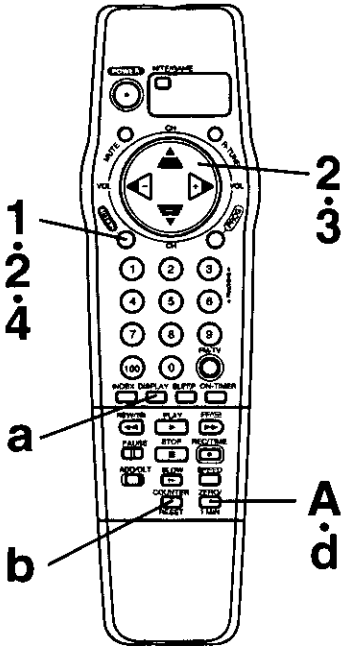

## Repeat Play

You can set your Combination VCR up to play a recording over and over.

**1** Press **ACTION** to display the MAIN MENU.

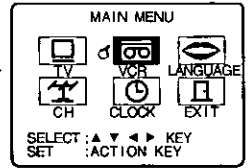

**2** Press **▲▼◀▶** to select "VCR," and then press **ACTION** to display the SET UP VCR screen.

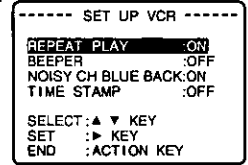

**3** Press **▲▼** to select "REPEAT PLAY," and then press **▶** repeatedly to select "ON" or "OFF."

- When **REPEAT PLAY : ON** is selected (the REPEAT indicator lights on the front panel during playback), the Combination VCR will playback the tape to its end, or until a blank portion of 30 seconds or more is reached. (Erased portions of tape are not considered blank.) The tape is then automatically rewound and played again. This operation is repeated until you cancel Repeat Play.
- All function buttons (REW, FF, etc.) are operational during Repeat Play.

**4** Press **ACTION** twice to return to the normal screen.



You may also turn the repeat play feature on and off at the Combination VCR. During playback, press **PLAY/REPEAT** on the Combination VCR once or twice until the REPEAT indicator lights up (ON), or goes out (OFF).

## Auto Operation Functions

### Auto Shut Off

In **TV** or **NITE/GAME** mode, when a broadcast signal is not received for 5 minutes, the Combination VCR will automatically power off (except when **LINE INPUT** is selected).

In **Playback** mode, when a Video signal is not detected for 5 minutes, the Combination VCR will automatically power off and the tape will be rewound.

- This feature is deactivated when any button on the unit or remote control is pressed even if there is no signal present.

### Auto Playback

When a tape is inserted, the power turns on (Auto). If the record tab\* is removed, playback begins (Auto).

### Auto Rewind

When a tape reaches its end during playback or fast forward the Combination VCR will rewind the tape and go into Stop mode.

### Playback Auto Eject (Repeat Play is "OFF.")

When a tape without a record tab\* is played to its end, the Combination VCR will rewind and then eject the tape.

### Memory Rewind Off

When **POWER** is pressed during tape rewind, rewinding will be completed even though the Combination VCR turns off.

\* For record tab information, see page 25.

## One Minute Skip

With this feature, you can skip over commercials recorded on a tape.

**A** Press **ZERO/1 MIN** in Play mode.

- The Combination VCR will go into FF search mode and skip over 60 seconds of recorded time. Then, normal playback will resume.

## Zero Search

You can reset the Time Counter to zero and then return to that point.

**a** Press **DISPLAY** to display the Time Counter overlay during playback.

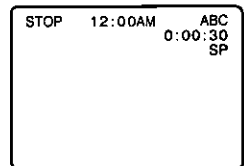

**b** Press **COUNTER RESET** to reset the Time Counter to "0:00:00" at the desired position.

**c** Continue playback, rewind, or fast forward.

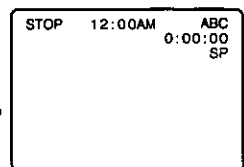

**d** Press **ZERO/1MIN** in Stop mode when you want to return to "0:00:00."

- The Combination VCR will go into FF or REW mode and stop at the last point the Time Counter was set to 0:00:00.





# Unit and Cassette Information

## Maximum Record/Playback Time

Only use tapes with the **VHS** mark in this unit.

Tape Speed Setting	Type of Video Cassette		
	T60	T120	T160
SP (Standard Play)	1 Hour	2 Hours	2 Hours 40 minutes
LP (Long Play)	2 Hours	4 Hours	5 Hours 20 minutes
SLP (Super Long Play)	3 Hours	6 Hours	8 Hours

## Build-in Head Cleaner <For Model PV-M2038 only>

A clean video head helps produce a clear picture. So, we have equipped your Combination VCR with a built-in, non chemical head cleaning system that helps prevent clogging of the video heads. Cleaning is performed each time you load or unload a video cassette.

**Note:** This feature is preventative only. If your video heads are seriously clogged, consider the use of a chemical nonabrasive head cleaning kit or take your Combination VCR to a Service Center.

## DST. (Daylight Saving Time)

Your Combination VCR can be set to automatically adjust the clock for Daylight Saving Time. (page 9.)

### Spring (First Sunday in April)

When set to DST:ON, the Combination VCR will automatically set the clock ahead one hour.

### Autumn (Last Sunday in October)

When set to DST:ON, the Combination VCR will automatically set the clock back one hour.

- If your area does not observe Daylight Saving Time, select DST: OFF.
- Keep these time changes in mind when programming the Combination VCR for timer recordings.

## Erase Protection (Record Tab)

Cassettes have a record tab to ensure that recordings are not accidentally erased.

To prevent accidental erasure, break off the tab with a screwdriver.



To record again, cover the hole with cellophane tape.



## Reset all Combination VCR Memory Functions

Use when moving the Combination VCR to a new location, or if a mistake was made in the One Time Setup section.

- Make sure a tape is not inserted in the Combination VCR.
- 1) Press POWER to turn the Combination VCR on.
  - 2) Hold down both the PLAY and REWIND buttons on the Combination VCR for more than 5 seconds.
    - The power will shut off.
  - 3) Turn the power back on and perform the One Time Setup section on page 8.

## Head Cleaning

Your Combination VCR will not normally require head cleaning, however, the heads may become clogged when playing an old or damaged tape.

### Head Clog Sensor

If head cleaning becomes necessary, the Combination VCR will display the screen shown to the right during playback of a video tape. To exit this screen, press PLAY on the remote control or Combination VCR.

VIDEO HEADS MAY  
NEED CLEANING  
PLEASE INSERT HEAD  
CLEANING CASSETTE  
OR REFER TO MANUAL

END:PLAY KEY

- Use "dry" type head cleaning cassette\* only.
  - Be sure to follow the cleaning cassette instructions carefully. Excessive use of a cleaning cassette can shorten head life.
  - If using a head cleaning cassette does not solve the problem, contact your nearest Factory Service Center or authorized Service Center. (See page 27.)
- \* Cleaning cassette part No. NV-TCL30PT is recommended.

## Product Specifications

### Display

Picture Tube: 13 inch measured diagonal 90° deflection Picture Tube  
<PV-M1348/PV-M1358W/PV-M1368>  
20 inch measured diagonal 90° deflection Picture Tube <PV-M2038>

### VCR

Video Recording System: 2 rotary heads helical scanning system  
<PV-M1348/PV-M1358W/PV-M2038>  
4 rotary heads helical scanning system <PV-M1368>

### Audio Track:

1 track

### Tuner

Broadcast Channels: VHF 2~13, UHF 14~69  
CABLE Channels: Midband A through I (14~22)  
Superband J through W (23~36)  
Hyperband AA~EEE (37~64)  
Lowband A-5~A-1 (95~99)  
Special CABLE channel 5A (01)  
Ultraband 65~94, 100~125

### FM Radio

Band range: 87.5~108.1 MHz

### General

Power Source: 120V AC, 60 Hz  
Power Consumption: Power on  
Approx. 69 watts  
<PV-M1348/PV-M1358W/PV-M1368>  
Approx. 110 watts <PV-M2038>  
Power off  
Approx. 5 watts

### Television System:

EIA Standard NTSC color

### Speaker:

1 piece

Operating Temperature: 41°F~104°F (5°C~40°C)

Operating Humidity: 10%~75%

### Weight:

26.4 lbs. (12 Kg)  
<PV-M1348/PV-M1358W/PV-M1368>  
50.6 lbs. (23 Kg) <PV-M2038>  
15-3/16" (W) X 15-3/16" (H) X  
16-11/16" (D)  
386(W) X 385(H) X 424(D) mm  
<PV-M1348/PV-M1358W/PV-M1368>  
20-5/16" (W) X 19-7/8" (H) X  
19-1/16" (D)  
515 (W) X 505 (H) X 484 (D) mm  
<PV-M2038>

### Dimensions:

Note: Designs and specifications are subject to change without notice.



# Before Requesting Service

Check the following points once again if you are having trouble with your Combination VCR.

<b>Power</b>	<b>Correction</b>
No power...	<ul style="list-style-type: none"> <li>• Completely insert the Power Plug into an AC wall outlet.</li> <li>• Set the POWER button to ON.</li> </ul>
<b>Monitor</b>	<b>Correction</b>
No picture or sound...	<ul style="list-style-type: none"> <li>• Make sure your antenna or cable system is connected to the Combination VCR. (P. 5)</li> <li>• Check that the power plug is completely plugged into an AC outlet.</li> <li>• Check that the POWER button is set to on.</li> </ul>
Poor picture with normal sound...	<ul style="list-style-type: none"> <li>• Adjust the BRIGHT, SHARPNESS, and PICTURE controls in the SET UP TV menu. (P.12)</li> </ul>
Poor sound with normal picture...	<ul style="list-style-type: none"> <li>• Adjust the VOLUME control. (P.11)</li> </ul>
Poor TV reception...	<ul style="list-style-type: none"> <li>• Adjust the SHARPNESS and PICTURE controls in the SET UP TV menu. (P.12)</li> </ul>
No color or poor color...	<ul style="list-style-type: none"> <li>• Adjust the TINT and COLOR controls in the SET UP TV menu. (P.12)</li> </ul>
Ghost (multiple) images...	<ul style="list-style-type: none"> <li>• Install a directional antenna.</li> </ul>
TV programs cannot be watched...	<ul style="list-style-type: none"> <li>• Make sure that the channel being received is in the Combination VCR's memory. (P. 8)</li> </ul>
Channel can not be selected...	<ul style="list-style-type: none"> <li>• The design of this unit is such that only the channel being recorded can be viewed.</li> </ul>
<b>VCR</b>	<b>Correction</b>
TV program cannot be recorded...	<ul style="list-style-type: none"> <li>• Make sure your antenna or cable system is connected to the Combination VCR. (P. 5)</li> <li>• Make sure that the record tab is intact on the cassette. (P. 25)</li> </ul>
Timer recording cannot be performed...	<ul style="list-style-type: none"> <li>• Set the recording Start/Stop time correctly. (P.18-19)</li> <li>• Timer recording may not be performed or continued if a power interruption of more than 1 minute occurs before or during a Timer Recording, after power is restored.</li> </ul>
No playback picture, or the playback picture is noisy or contains streaks...	<ul style="list-style-type: none"> <li>• Adjust the TRACKING control in either direction. (P.16)</li> </ul>
VCR cannot be controlled...	<ul style="list-style-type: none"> <li>• Make sure that VCR LOCK is set to off. (P. 21)</li> </ul>
<b>Remote Control</b>	<b>Correction</b>
Combination VCR cannot be controlled...	<ul style="list-style-type: none"> <li>• Aim the Remote Control directly at the remote sensor on the Combination VCR. (P. 7)</li> <li>• Avoid all obstacles which may interfere with the signal path.</li> <li>• Inspect the remote batteries for possible replacement. (P. 4)</li> <li>• Make sure that VCR LOCK is set to off. (P. 21)</li> <li>• Exposing the Combination VCR remote sensor to direct fluorescent or outdoor light may cause signal interference.</li> </ul>
<b>Miscellaneous</b>	<b>Correction</b>
Video cassette cannot be inserted...	<ul style="list-style-type: none"> <li>• Insert the cassette window side up; record tab facing you.</li> </ul>
Video cassette cannot be removed...	<ul style="list-style-type: none"> <li>• Check that the power plug is completely plugged into an AC outlet.</li> </ul>
Eject does not function or insertion cannot be done...	<ul style="list-style-type: none"> <li>• Turn the POWER off and then on, and try ejecting or inserting the tape again.</li> </ul>
Video cassette ejects when a recording is started, or the power is turned off for timer recording...	<ul style="list-style-type: none"> <li>• Make sure the record tab is intact on the cassette. (P. 25)</li> </ul>
In stop mode, the VCR motor (CYLINDER) continues to rotate...	<ul style="list-style-type: none"> <li>• To enable the quick play mechanism, the VCR cylinder will rotate for about 5 minutes. This reduces response time from Stop to Play mode and from Play to Rewind Search mode.</li> </ul>
VCR cannot be controlled...	<ul style="list-style-type: none"> <li>• Make sure that VCR LOCK is set to off. (P. 21)</li> </ul>

If you cannot resolve the problem, please call the Customer Satisfaction Center for product assistance at 201-348-9090.

To locate an authorized servicenter call toll free 1-800-211-PANA(7262).

# Service Center List

For Product Information, Operating Assistance, Literature Request, Dealer Locations, and all Customer Service inquiries please contact:  
**800-211-PANA (7262)**, Monday-Friday 9 am-9 pm Saturday-Sunday 9 am-7 pm, EST.

Web Site: <http://WWW.Panasonic.com>  
You can purchase parts, accessories or locate your nearest servicer by visiting our Web Site.

## Factory Servicenters Locations

### CALIFORNIA

6550 Katella Avenue  
Cypress, CA 90630

800 Dubuque Avenue  
S. San Francisco,  
CA 94080

20201 Sherman Way  
Suite 102  
Canoga Park, CA  
91306

3878 Ruffin Road  
Suite A  
San Diego, CA 92123

### COLORADO

1640 South Abilene  
Street  
Suite D  
Aurora, CO 80012

### FLORIDA

3700 North 29<sup>th</sup> Avenue  
Suite 102  
Hollywood, FL 33020

### GEORGIA

8655 Roswell Road  
Suite 100  
Atlanta, GA 30350

### ILLINOIS

1703 North Randall  
Road  
Elgin, IL 60123  
(Pick-up/Drop-off only)

9060 Golf Road  
Niles, IL 60714

### MARYLAND

62 Mountain Road  
Glen Burnie, MD21061

### MASSACHUSETTS

60 Glacier Drive,  
Suite G  
Westwood, MA 02090

### MICHIGAN

37048 Van Dyke  
Avenue  
Sterling Heights,  
MI 48312

### MINNESOTA

7850-12<sup>th</sup> Avenue South  
Airport Business Center  
Bloomington, MN 55425

### OHIO

2236 Waycross Road  
Civic Center Plaza  
Forest Park, OH 45240

### PENNSYLVANIA

2221 Cabot Blvd West  
Suite B  
Langhorne, PA 19047

Chartiers Valley  
Shopping Center  
1025 Washington Pike  
Bridgeville, PA 15017

### TENNESSEE

919-8<sup>th</sup> Avenue South  
Nashville, TN 37203

### TEXAS

7482 Harwin Drive  
Houston, TX 77036

13615 Welch Road  
Suite 101  
Farmers Branch,  
TX 75244

### WASHINGTON

20425-84<sup>th</sup> Avenue  
South  
Kent, WA 98032

### HAWAII

99-859 Iwaiwa Street  
Aiea, Hawaii 96701  
Phone (808) 488-1996  
Fax (808) 486-4369

## Service in Puerto Rico

Matsushita Electric of Puerto Rico, Inc. Panasonic Sales Company/Factory Servicer:  
Ave. 65 de Infanteria, Km. 9.5, San Gabriel Industrial Park, Carolina, Puerto Rico 00985  
Phone (787) 750-4300 Fax (787) 768-2910

## Accessory Purchases:

Customer Orders Only 800-211-PANA(7262)

# Spanish Quick Use Guide/Guía para rápida consulta

## Conexión de la antena externa

Desenganche la antena del televisor o de la videograbadora que tuviera anteriormente y conéctela a la parte trasera del registrador Combinación de VCR/TV, como se muestra en el diagrama. Si el sistema de su antena tiene conductores UHF y VHF separados, usted necesita un mezclador de banda UHF/VHF (no viene con el equipo).

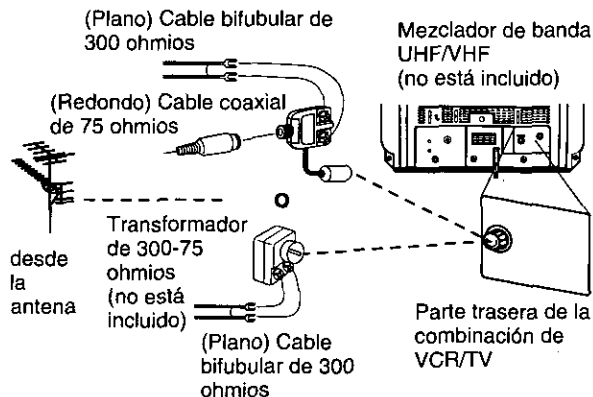

El modelo que aparece aquí es el PV-M2038 con mando a distancia.

## Conexiones de TV por cable

### (A) Sin la caja convertidora/decodificadora

Con esta conexión usted podrá utilizar su control remoto de la combinación de VCR/TV para seleccionar los canales que desea ver y seleccionar canales no codificados para su grabación programada. Esta conexión no permite ver ni grabar canales codificados.

### (B) Con una caja convertidora/decodificadora

Con esta conexión, usted podrá grabar y ver cualquier canal, incluyendo los canales codificados. Sin embargo, la selección de canales se debe efectuar en la caja convertidora de TV por cable que suministra esta empresa. La grabación programada está limitada a un canal cada vez, y sólo se podrá ver el canal que esté grabando.

(A)

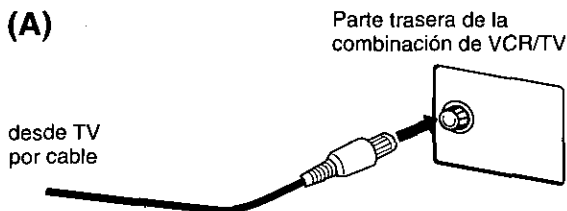

El modelo que aparece aquí es el PV-M2038 con mando a distancia.

(B)

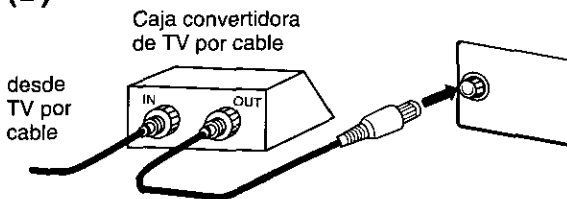

El modelo que aparece aquí es el PV-M2038 con mando a distancia.

## Para ver y grabar un canal codificado/no codificado

Sintonice el canal del Registrador de la combinación de VCR/TV en el canal de salida de la caja convertidora de televisión por cable (por ejemplo el canal 3). Después, seleccione en la caja convertidora de TV por cable el canal que se quiera ver o grabar.

## Para fijar el idioma, canal y reloj

Al encender la combinación de VCR/TV por primera vez, aparecerán las pantallas para fijar automáticamente los canales y el reloj.

**1** Oprimir POWER para encender el aparato.

**2** Oprimir CH ▲▼, o VOL ► para la exhibición de la pantalla en inglés, español o francés.

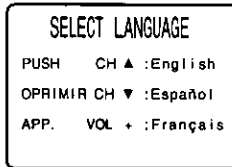

**Importante:** si está usando una caja de TV por cable, encienda la caja y sintonice al canal PBS de su zona.

**3** Oprimir CH ▲ para iniciar la fijación de los canales y el reloj.



Las siguientes informaciones aparecerán seguidamente:

- AUTOPROGRAMACION EN PROCESO
- AUTOPROGRAMACION COMPLETO
- FIJACION AUTOMATICA DEL RELOJ EN PROCESO

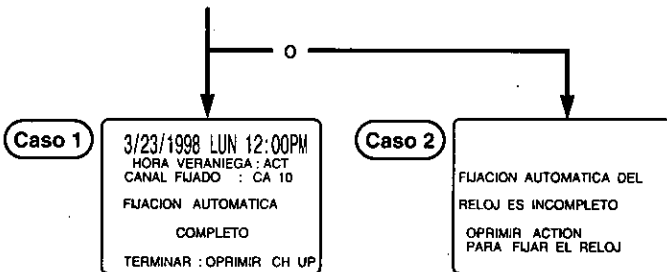

**4** **Caso 1** Si la hora demostrada es correcta, oprima CH ▲ para salir.

**Si la hora y la hora veraniega es incorrecta,**

Raras veces, en caso de que ud. vive cerca de dos zonas con hora diferente, el aparato puede elegir un canal PBS con diferente hora de su zona. En este caso, haga los siguientes pasos:

- Tome nota del canal que está fijado en la pantalla y salga desde este modo oprimiendo el botón ▲.
- Anule este canal desde los canales memorizados en la combinación de VCR/TV.
- Oprima el botón ACTION para que aparezca la pantalla del MENU.
- Oprima ▲▼◀▶ para elegir "RELOJ" y luego oprima ACTION para que aparezca la pantalla de FIJACION DEL RELOJ.
  - Si ud. esta usando una caja de TV por cable y tiene muchos canales PBS, sintonice la caja de TV por cable a un canal PBS diferente e intente la fijación automática otravez usando el menú.
- Oprima ▲▼ para elegir "FIJACION AUTOMATICA", luego oprimir ► para fijar y oprimir ▲ para iniciar.

**Caso 2** Si aparece FIJACION AUTOMATICA DEL RELOJ ES INCOMPLETO, por favor fije el reloj manualmente.

- Oprimir ACTION para que aparezca la pantalla de la fijación del reloj
- Oprimir ▲▼ para elegir y oprimir ► para fijar el mes, la fecha, el año, la hora y la hora veraniega.

**Para hacer correcciones,**

Oprimir ◀▶ repetidamente para retroceder o avanzar hasta el paso que desea corregir.

- Oprimir ACTION para iniciar a funcionar el reloj. Luego oprimir ▲▼◀▶ para elegir "SALIR" y oprimir ACTION para salir de la pantalla del MENU PRINCIPAL.

## Para fijar o fijar de nuevo el reloj

En caso de que el reloj es incorrecto o ha ocurrido un corte eléctrico.

- Oprima ACTION para que parezca el MENU PRINCIPAL.
- Oprima ▲▼◀▶ para elegir "RELOJ". Luego, oprima ACTION para que aparezca la pantalla de la FIJACION DEL RELOJ.
- Oprima ▲▼ para elegir "MANUAL", y luego ► para que aparezca la pantalla de la FIJACION DEL RELOJ.
- Por favor continúe con los pasos b. y c. de la instrucción anterior (Caso 2).

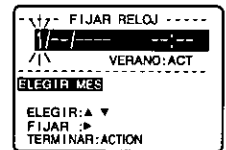

## Operaciones para ver la TV

- Oprimir POWER para encender la combinación de VCR/TV.
- Elegir el canal usando ▲▼, o usando la teclas numéricas.
- Oprimir VOL ◀▶ para ajustar el nivel del volumen.

## Encendedor automático con alarma

La combinación de VCR/TV se puede fijar para que se encienda automáticamente en uno de los tres modos (TV, reproducción o radio FM). Ud. también puede combinar con un alarma despertador de un minuto.

- 1 Oprimir ON TIMER para que aparezca la pantalla del encendedor automático.

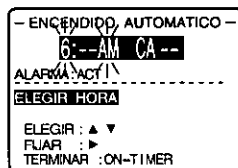

- 2 Oprimir ▲▼ para elegir y oprimir ► para fijar la hora del encendedor automático y luego para elegir el modo (TV, reproducción o radio FM).

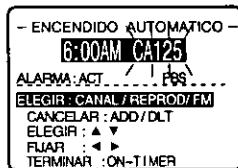

Vea el orden para elegir a la derecha.

- Asegúrese de que una cinta de video esté introducido en la combinación de VCR/TV, si ha elegido la reproducción de la videogradora.

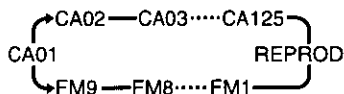

- 3 Oprimir ▲ para elegir la fijación del alarma.

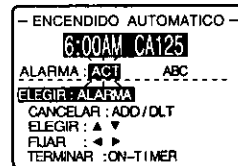

Si ha elegido "ACT", sonará un alarma por un minuto o hasta cancelar oprimiendo cualquiera de las teclas del control remoto. Cuando se apaga el alarma, sonará el sonido del modo que ha elegido.

Para hacer correcciones, use ▲▼ y ◀▶ para retroceder o avanzar como se necesita.

- 4 Oprimir ON TIMER para fijar la función del encendedor automático. Esta pantalla aparecerá cerca de 5 segundos.

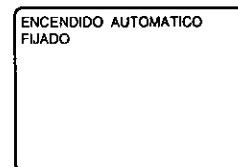

- El indicador de ON TIMER (encendedor automático) se encenderá en el panel delantero.

Para cancelar, oprima ON-TIMER para que aparezca de nuevo la pantalla del paso 3. Luego, oprima ADD/HLT para anular la hora ("6" destellará). Ahora, oprima ON-TIMER para terminar. "ENCENDIDO AUTOMATICO ANULADO" aparecerá unos segundos en la pantalla.

60 minutos luego de que la combinación de VCR/TV se ha encendido automáticamente, éste se apagará por sí mismo si no se ha oprimido ningún botón del control remoto o del aparato.

## Fijación del temporizador para dormir

La combinación de VCR/TV se puede fijar para que se apague automáticamente.

- Oprimir SLEEP para que aparezca el tiempo de la fijación.

- Si ud. oprime el botón DISPLAY con el temporizador para dormir fijado, aparecerá en la pantalla el tiempo que sobra para apagarse

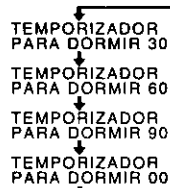

Para cancelar, oprimir SLEEP sucesivamente hasta que aparezca "TEMPORIZADOR PARA DORMIR 00".

## Operaciones básicas para la reproducción

- 1 Introducir una cinta.

- La combinación de VCR/TV se enciende automáticamente.

- 2 Oprimir PLAY en el control remoto o combinación de VCR/TV para comenzar a reproducir.

- Si la cinta no tiene la lengüeta para evitar el borrado, la combinación de VCR/TV comienza a reproducir automáticamente.

- 3 Oprimir STOP en el control remoto o combinación de VCR/TV para parar la reproducción.

- Para rebobinar la cinta, oprimir REW.

- 4 Oprimir STOP/EJECT en la combinación de VCR/TV para expulsar la cinta.

- Usted puede expulsar la cinta cuando el aparato está encendido o apagado.

## Para buscar una escena en particular durante la reproducción

Oprimir REW o FF durante la reproducción para buscar una escena.

- La velocidad de la búsqueda es a 7 veces más rápida en el modo SP <sólo para PV-M1368> y 21 veces más rápida en el modo SLP.

## Operaciones básicas para la grabación

- 1** Introducir una cinta de video que tenga la lengüeta para evitar el borrado.

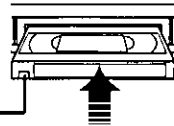

- La combinación de VCR/TV se enciende automáticamente.

- 2** Oprimir **▲▼** o las teclas numéricas para elegir un canal.

- U oprimir **▲▼** de la combinación de VCR/TV.
- Para grabar desde una fuente externa, oprimir **▲▼** y elija LINEA.

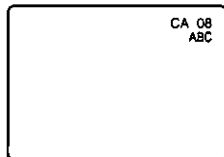

- 3** Oprimir **SPEED** hasta que aparezca la velocidad deseada.

- SP = reproducción normal
- LP = reproducción larga
- SLP = reproducción super larga



- 4** Oprimir **REC/TIME** del control remoto para empezar a grabar.

- U oprimir **REC/TIME** de la combinación de VCR/TV.
- Oprimir **PAUSE** para hacer una pausa en la grabación de un toque.

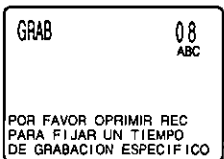

### Grabación de un toque (OTR)

La combinación de VCR/TV se puede fijar para para la grabación a una hora fijada anteriormente.

En el paso 4, oprimir repetidamente **REC/TIME** para fijar el tiempo de grabación.

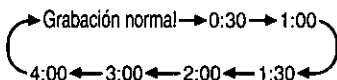

- La luz indicador de la grabación programada (TIMER) se enciende en el panel delantero.

## Grabación con temporizador

- 1** Oprimir **PROG** para exhibir la pantalla de la programación."

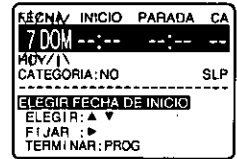

- Si ya existe una programación memorizada, oprima **▲▼** y **►** para elegir un número sin programación.

- 2** Oprimir **▲▼** y **►** para elegir y fijar uno de los siguientes:

1~31 = Grabación de una sola vez

DIARIO = A una misma hora LUN -VIE

SEMANAL DOM-SAB = Una vez a la semana a una misma hora

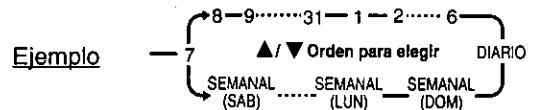

- 3** Oprimir **▲▼** y **►** para elegir y fijar las siguientes fijaciones.

#### Fijaciones:

- Hora de inicio
- Hora de parada
- Canal o LINEA para una fuente externa
- Categoría (NO, DEPOR, CINE, COMEDI, MUSICA, DRAMA)
- Velocidad de la cinta (SP, LP, SLP)

#### Para hacer correcciones

Oprimir **►** sucesivamente para avanzar u **◀** para retroceder hasta el paso que desea corregir.

- 4** Oprimir **PROG** para terminar la programación.

#### Para hacer más programaciones

Oprimir **▲▼** y **►** para elegir y fijar un número de programación en blanco y luego repita los pasos 2 y 3.

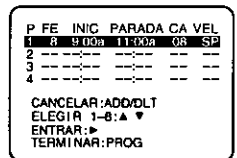

- 5** Oprimir **PROG** para salir desde este modo y volver a la pantalla normal.

- La luz indicador de la grabación programada (TIMER) se enciende en el panel delantero.
- Si ud. está usando una caja de TV por cable, asegúrese de que esté sintonizado el canal deseado y que esté encendido para la grabación con temporizador.

Dos minutos antes de empezar la grabación, "GRABACION PROGRAMADA INICIARA ENSEGUIDA" aparecerá en la pantalla.

- 5** Oprimir **STOP** para parar la grabación.

- U oprimir **STOP/EJECT** de la combinación de VCR/TV.

# Warranty

Panasonic Consumer Electronics Company,  
Division of Matsushita Electric Corporation  
of America,  
One Panasonic Way  
Secaucus, New Jersey 07094

Panasonic Sales Company,  
Division of Matsushita Electric of Puerto Rico, Inc.  
AVE. 65 de Infanteria, Km. 9.5  
San Gabriel Industrial Park  
Carolina, Puerto Rico 00985

## PANASONIC Video Products Limited Warranty

Panasonic Consumer Electronics Company or Panasonic Sales Company (collectively referred to as "the Warrantor") will repair this product with new or refurbished parts, free of charge, in the USA or Puerto Rico, in the event of a defect in materials or workmanship as follows (all time periods commence from the date of the original purchase):

<u>PRODUCT</u>	<u>PARTS</u>	<u>LABOR</u>
CAMCORDER	ONE (1) YEAR, EXCEPT CCD IMAGE SENSOR CCD IMAGE SENSOR - SIX (6) MONTHS	NINETY (90) DAYS NINETY (90) DAYS
VCR	ONE (1) YEAR	NINETY (90) DAYS
A/V MIXER	ONE (1) YEAR	NINETY (90) DAYS
MONITOR-VCR	ONE (1) YEAR, EXCEPT CRT CRT - TWO (2) YEARS	NINETY (90) DAYS CRT - NINETY (90) DAYS CUSTOMER PAYS ALL LABOR CHARGES AFTER 90 DAYS

**Monitor-VCR In-home or carry-in Service: 22" (diagonal) CRT / LCD and Larger**  
**Monitor-VCR Carry-in Service: 21" (diagonal) CRT / LCD and smaller**

Batteries (if included) - New rechargeable batteries in exchange for defective rechargeable batteries for ten (10) days. Non-rechargeable batteries are not warranted.

Tape (if included) - New video cassette tape in exchange for a defective video cassette tape for five (5) days.

In-home, carry-in or mail-in service, as applicable, in the USA can be obtained during the warranty period by contacting a Panasonic Services Company (PASC) Factory Servicenter listed in the Service Directory. Or call toll free 1-800-211-PANA(7262), to locate an authorized PASC Servicenter. Carry-in or mail-in service in Puerto Rico can be obtained during the warranty period by calling the Panasonic Sales Company telephone number listed in the Servicenter Directory.

This warranty is extended only to the original purchaser. A purchase receipt or other proof of the date of the original purchase is required before warranty service is rendered.

This warranty only covers failures due to defects in materials and workmanship which occur during normal use and does not cover normal maintenance, including, but not limited to, video and audio head cleaning. The warranty does not cover damage which occurs in shipment, or failures which are caused by products not supplied by the warrantor, or failures which result from accident, misuse, abuse, neglect, mishandling, misapplication, alteration, modification, faulty installation, set-up adjustments, improper antenna, inadequate signal pickup, maladjustment of consumer controls, improper operation, power line surge, improper voltage supply, lightning damage, commercial use such as hotel, office, restaurant, or other business or rental use of the product, or service by anyone other than a PASC Factory Servicenter or a PASC authorized Servicenter, or damage that is attributable to acts of God.

### LIMITS AND EXCLUSIONS

There are no express warranties except as listed above.

THE WARRANTOR SHALL NOT BE LIABLE FOR INCIDENTAL OR CONSEQUENTIAL DAMAGES (INCLUDING, WITHOUT LIMITATION, DAMAGE TO TAPES) RESULTING FROM THE USE OF THIS PRODUCTS, OR ARISING OUT OF ANY BREACH OF THE WARRANTY. ALL EXPRESS AND IMPLIED WARRANTIES, INCLUDING THE WARRANTIES OF MERCHANTABILITY AND FITNESS FOR PARTICULAR PURPOSE, ARE LIMITED TO THE APPLICABLE WARRANTY PERIOD SET FORTH ABOVE. Some states do not allow the exclusion or limitation of incidental or consequential damages, or limitations on how long an implied warranty lasts, so the above exclusions or limitations may not apply to you.

This warranty gives you specific legal rights and you may also have other rights which vary from state to state.

If a problem with this product develops during or after the warranty period, you may contact your dealer or Servicenter. If the problem is not handled to your satisfaction, then write to the Customer Satisfaction Center at the Panasonic Consumer Electronics Company address above.

SERVICE CALLS WHICH DO NOT INVOLVE DEFECTIVE MATERIALS OR WORKMANSHIP AS DETERMINED BY THE WARRANTOR, IN ITS SOLE DISCRETION, ARE NOT COVERED. COSTS OF SUCH SERVICE CALLS ARE THE RESPONSIBILITY OF THE PURCHASER.

warvid 10/20/97

Panasonic Consumer Electronics Company,  
Division of Matsushita  
Electric Corporation of America  
One Panasonic way Secaucus, New Jersey 07094

Printed in U.S.A.  
VQTS3410 (A)

Panasonic Sales Company,  
Division of Matsushita Electric of  
Puerto Rico, Inc. ("PSC")  
Ave. 65 de Infantería, Km. 9.5  
San Gabriel Industrial Park, Carolina,  
Puerto Rico 00985

